

**Tools Required**

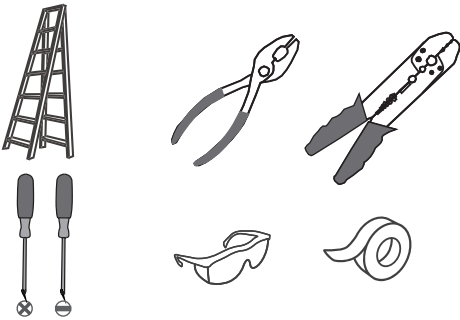

**Light Source**

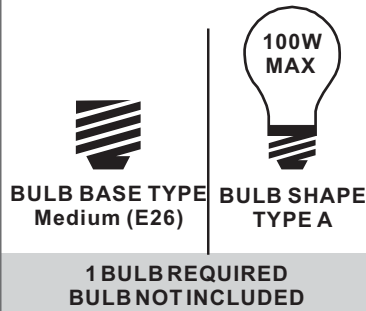

**Fixture Height Adjustable 13.5" to 99.5"**

**⚠ Warnings and Cautions**

Turn off the electricity at the circuit breaker before installation. Consult a licensed electrician if in doubt about installation.

Turn off power to the fixture and allow the bulbs to cool before replacing.

**Package Contents**

**Preparation:** Identify and inspect all parts before beginning the installation.

Missing or damaged parts? Contact your original place of purchase.

**PARTS BAG**

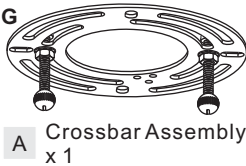

**A** Crossbar Assembly x 1



**B** Outlet Box Screw x 2



**C** Wire Connector x 3

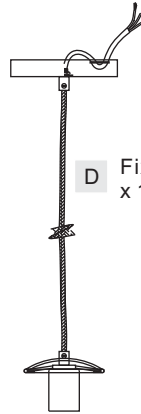

**D** Fixture Body x 1



**E** Lock Screw x 3

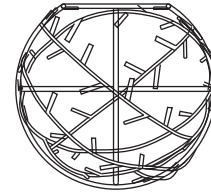

**F** Cage x 1

**Table of Contents**

**Crossbar Assembly**

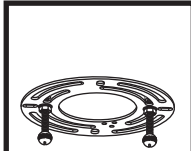

**STEP 1**

**Cord**

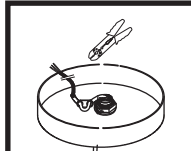

**STEP 2**

**Wiring**

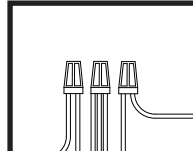

**STEP 3**

**Ceiling Canopy**

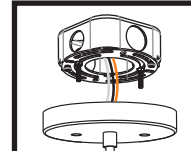

**STEP 4**

**Bulb**



**STEP 5**

**STEP 1**

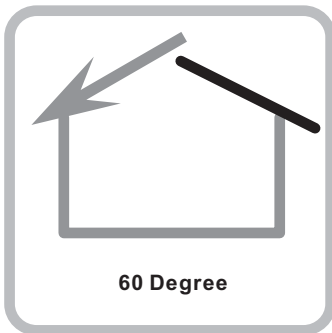

**60 Degree**

For angled ceilings, Swivel opening towards wall.

**1**

**Step 1**  
Install crossbar assembly

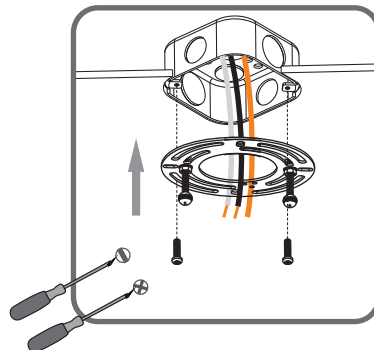

**2**

**Step 2 - 3**  
Test fitting ceiling canopy to mounting screws

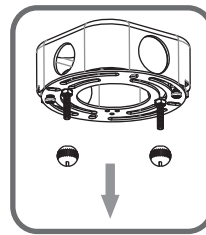

**3**

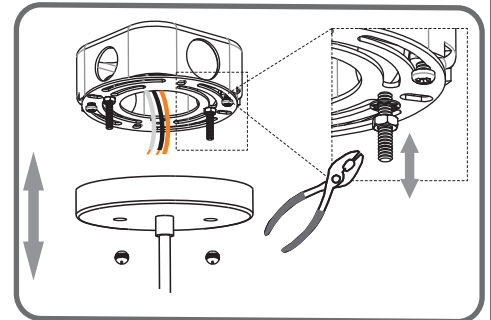

## STEP 2

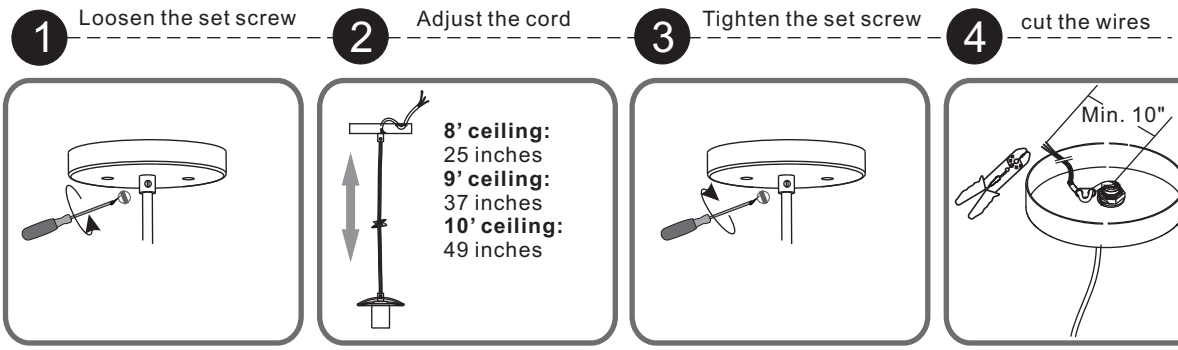

## STEP 3

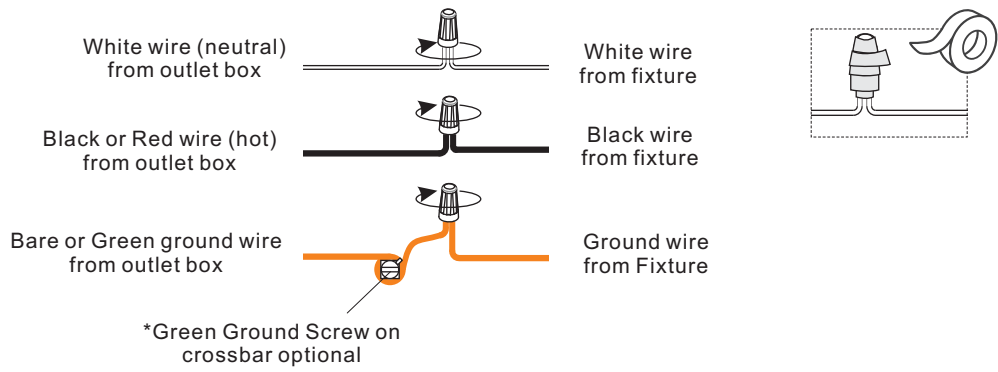

## STEP 4

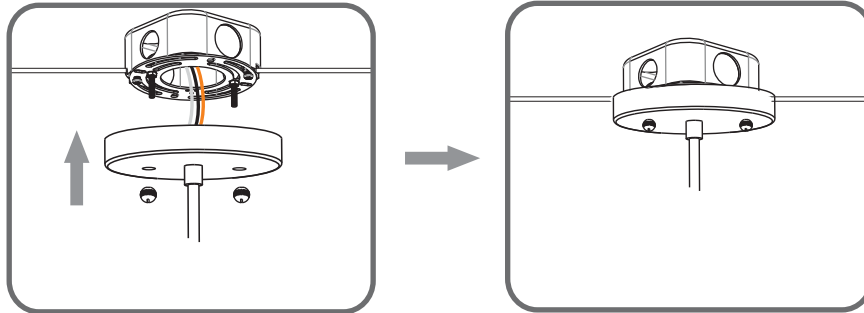

## STEP 5

