

Please go to www.quoise.com for product cleaning tips. Go to the **Care + Maintenance** selection.

Tools Required: Flathead screwdriver, Phillips screwdriver, pliers, wire cutters, wire strippers, electrical tape, safety glasses.

Light Source: (1) A19 Medium Base Bulb 100W Maximum, bulb not included.

Estimated Assembly Time: 20-30 minutes

Preparation: Identify and inspect all parts before beginning installation. Check package content list and diagrams below to ensure all parts are present. If any parts are missing or damaged, do not attempt to assemble, install, or operate the fixture. Contact your original place of purchase.

⚠ Warnings and Cautions

Turn off electricity at circuit breaker or main fuse box before installation. Consult a licensed electrician if in doubt.

These instructions are provided for your safety. It is very important you read them completely before installing the fixture. We strongly recommend that a licensed, professional electrician perform the installation.

Disconnect fixture from power source before replacing bulbs. Make sure bulbs are given sufficient time to cool before removal.

Package Contents

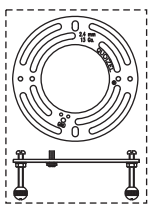

A Crossbar Assembly x 1



B Outlet Box Screw x 2



C Wire Connector x 3

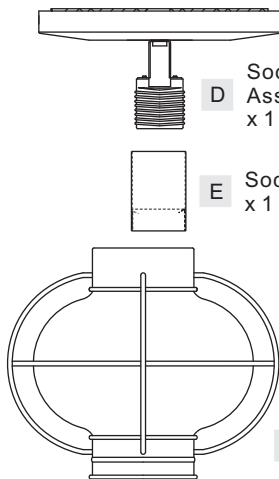

D Socket Assembly x 1

E Socket Collar x 1

F Shade x 1

(Step 3 Continued)

crossbar, no less than 2 inches from the end of the wire. Tighten the green ground screw.
B. Use standard Wire Connectors (C) to make all wire connections. Twist connectors until wires are tightly joined together. Wrap each connection with approved electrical tape and carefully stuff all the connected wires into the Outlet Box.

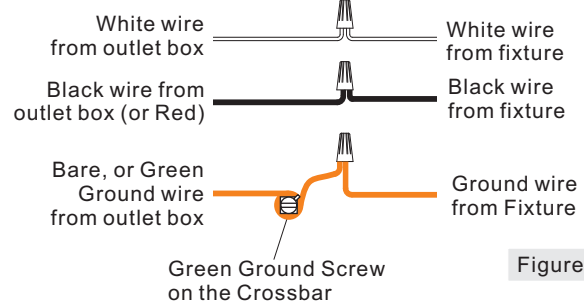
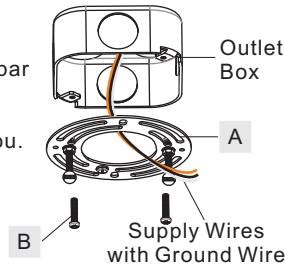

Figure 3

STEP 1 - Install Crossbar Assembly

A. Pass the supply wires through the Crossbar Assembly (A). Attach the Crossbar Assembly (A) to the outlet box with the head of the green ground screw facing you. Secure it with Outlet Box Screws (B). Tighten until snug.

Figure 1



STEP 2 - Test Fitting Ceiling Canopy to Crossbar Assembly

A. Remove mounting balls from the Crossbar Assembly (A). Fit the ceiling canopy on Socket Assembly (D) to the Crossbar Assembly (A) and secure with mounting balls. Note: The ceiling canopy on Socket Assembly (D) should be snug against the ceiling and the mounting balls. If not, adjust the length of the nipple on the Crossbar Assembly (A) by unscrewing the preassembled hex nut and lock washer and then screwing the mounting screws in or out of the crossbar until the correct length is achieved. Once the ceiling canopy on Socket Assembly (D) is secure, remove the mounting ball and ceiling canopy and proceed to Step 3.

Figure 2

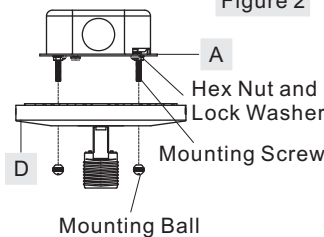

STEP 4 - Install Socket Assembly

A. Carefully tuck all wires into the outlet box and position the ceiling canopy of Socket Assembly (D) over the outlet box. Align the holes in the ceiling canopy with the mounting screws. Attach Socket Assembly (D) using the mounting balls. Hand tighten until snug.

Figure 4

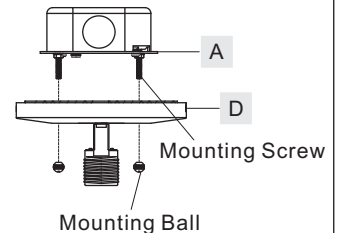

STEP 5 - Install Shade and Bulb

A. Place Key Holes side of Shade (F) over the socket. Pass Key Holes on the Shade (F) over Mounting Balls and rotate the Shade (F) until it is secured in place.
B. Thread the Socket Collar (E) to socket and hand tighten until snug.
C. Insert bulb onto socket and screw snugly into place.

Your fixture is now assembled and ready to use. Enjoy!

Figure 5

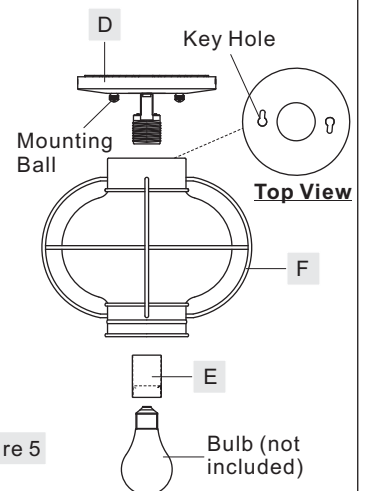

STEP 3 - Wire Connections

A. Wrap bare or green ground wire around green ground screw on the