

# Installation Instructions

## NUTP13 Series

### 120V Continuous IP65 Rated LED Tape Light

**READ PRIOR TO ATTEMPTING INSTALLATION**  
**ALWAYS TURN OFF MAIN POWER BEFORE INSTALLATION**  
**INSTALLATION SHOULD BE CARRIED OUT BY YOUR LOCAL ELECTRICIAN**

#### SAVE THESE INSTRUCTIONS

**⚠ WARNING** - When using outdoors; use portable lighting products, basic safety precautions should always be followed to reduce the risk of fire, electric shock and personal injury. Be sure the electrical power to the circuit has been disconnected before installing this electrical system. When connecting to outdoor circuit, make sure outlet/circuit includes Ground Fault Circuit Interrupter (GFCI) protection.

#### IMPORTANT SAFETY INSTRUCTIONS: READ AND FOLLOW ALL SAFETY INSTRUCTIONS

- Always turn off power prior to installation or replacement
- Do not cover luminaire as this may cause the tape light to overheat, melt or ignite
- Do not operate luminaire when tape light is tightly coiled
- Do not puncture, cut, shorten or splice the luminaire
- Do not route the cord or luminaire through walls, doors, windows or any like part of the building structure
- Do not use if there is any damage to the luminaire or cord insulation (inspect periodically)
- Do not submerge luminaire in liquids or use the product in the vicinity of standing water or other liquids
- Secure the tape light using only the mounting clips (provided) or channel (ordered separately). Do not secure luminaire or cord with staples, nails, or like means that may damage the insulation or permanently attach to the building structure.
- Do not subject luminaire to continuous flexing

#### MOUNTING INSTALLATION

1. Affix mounting brackets (two required per foot) to surface.
2. Mount tape light inside brackets.
3. Close the upper cover of the mounting clips.

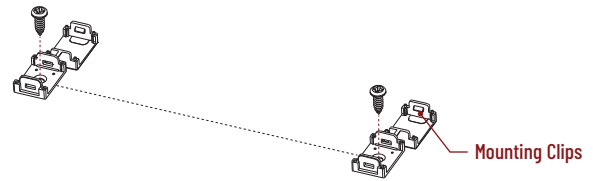

#### ALUMINUM CHANNEL INSTALLATION

1. Place channel (ordered separately) on the desired mounting surface and make the appropriate mounting holes (minimum of three holes).
2. Align and drill the aluminum channel holes.
3. Place channel onto mounting surface and insert screws (not included) through holes into surface.  
**NOTE:** NUTP13 does not have adhesive backing. Apply 3M™ adhesive double sided tape (ordered separately: NUTP13-ADHTAPE) when using tape in aluminum channels in indoor applications only.
4. Peel the film from one side of the 3M™ adhesive and apply to the back of the tape light.
5. Peel the remaining film to mount the tape light onto the aluminum channel.
6. Place the tape light into the aluminum channel and gently press down on the tape light to firmly secure.
7. Attach the lens to the aluminum channel.
8. Add end caps to complete installation.

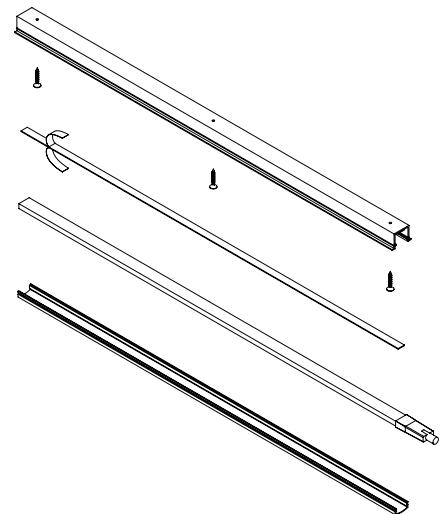

# Installation Instructions

## NUTP13 Series

### 120V Continuous IP65 Rated LED Tape Light

READ PRIOR TO ATTEMPTING INSTALLATION  
ALWAYS TURN OFF MAIN POWER BEFORE INSTALLATION  
INSTALLATION SHOULD BE CARRIED OUT BY YOUR LOCAL ELECTRICIAN

#### BENDING

- ⚠ **WARNING:** Single bend of 90° shall not exceed the minimum inside radius of 2" (50mm) as specified in the figure below..
- ⚠ **WARNING:** Do not bend on horizontal plane

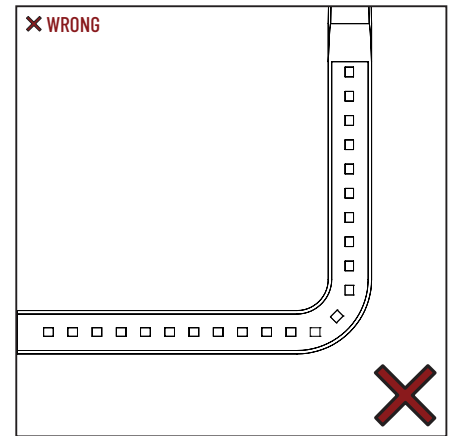
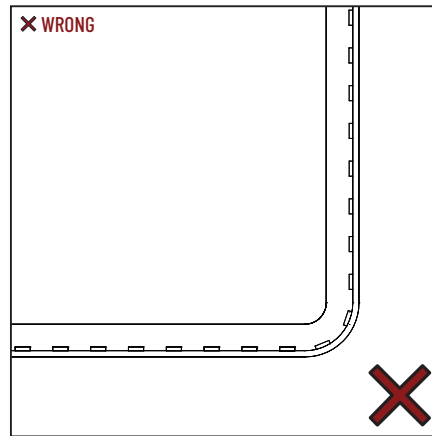
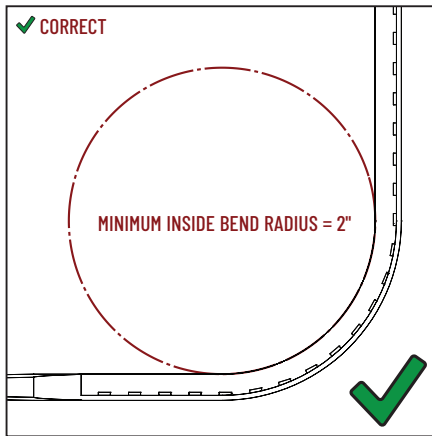

#### HARDWIRE INSTALLATION

1. Make sure power is off
2. Pull luminaire's hardwire cable to junction box and connect to supply wires according to NEC code
3. Turn power back on.

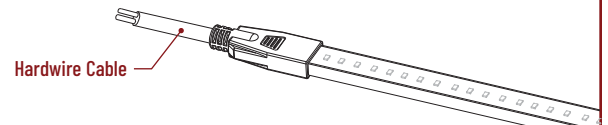

#### CORD AND PLUG INSTALLATION

**Note:** Luminaire has a polarized plug (wider pin for neutral and other for line) as a feature to reduce the risk of electric shock. This plug will fit in a polarized outlet only one way. If the plug does not fit fully in the outlet, reverse the plug. If it still does not fit, contact a qualified electrician. Do not use an extension cord unless plug can be fully inserted. Do not alter or replace the plug.

1. Make sure power is off
2. Connect cord and plug into receptacle (Note: When used outdoors, connect to GFCI outlet)
3. Turn power back on.

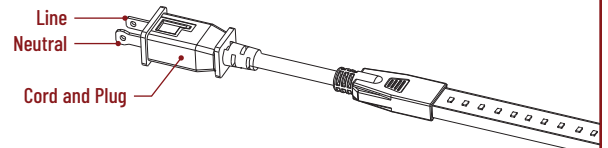

#### FUSE REPLACEMENT

1. Do not unplug by pulling on cord. Grasp plug and remove from the receptacle or other outlet device.
2. Slide to open fuse cover and remove fuse carefully.
3. Warning: Risk of fire! Replace fuse only with 8 Amp, 125V fuse (included)
4. Close fuse cover
5. Warning: Risk of fire! Do not replace attachment plug. Contains a safety device (fuse) that should not be removed.  
Discard product if the attachment plug is damaged.

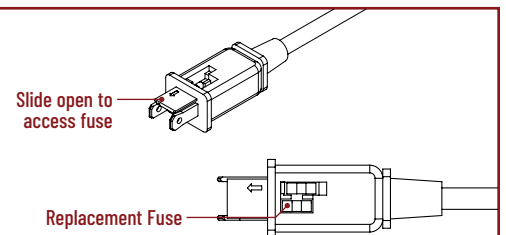

# Installation Instructions

## NUTP13 Series

### 120V Continuous IP65 Rated LED Tape Light

READ PRIOR TO ATTEMPTING INSTALLATION  
ALWAYS TURN OFF MAIN POWER BEFORE INSTALLATION  
INSTALLATION SHOULD BE CARRIED OUT BY YOUR LOCAL ELECTRICIAN

#### SURGE PROTECTOR INSTALLATION

**REQUIRES: NATL-IP65/SP (Ordered Separately)**

1. Turn all power off before installation.
2. Connect surge protector (NATL-IP65/SP - ordered separately) to supply wires and LED tape light hardwire cable (Note: Surge protector not compatible with cord & plug).
3. Installation complete.

