

Please go to www.quoizel.com for product cleaning tips. Go to the **Care + Maintenance** selection.

Tools Required: Flathead screwdriver, Phillips screwdriver, pliers, wire cutters, wire strippers, electrical tape, safety glasses.

Light Source: Integrated LED 40W

Estimated Assembly Time: 20-30 minutes

Preparation: Identify and inspect all parts before beginning installation. Check package content list and diagrams below to ensure all parts are present. If any parts are missing or damaged, do not attempt to assemble, install, or operate the fixture. Contact your original place of purchase.

⚠ Warnings and Cautions

Turn off electricity at circuit breaker or main fuse box before installation. Consult a licensed electrician if in doubt.

These instructions are provided for your safety. It is very important you read them completely before installing the fixture. We strongly recommend that a licensed, professional electrician perform the installation.

Package Contents

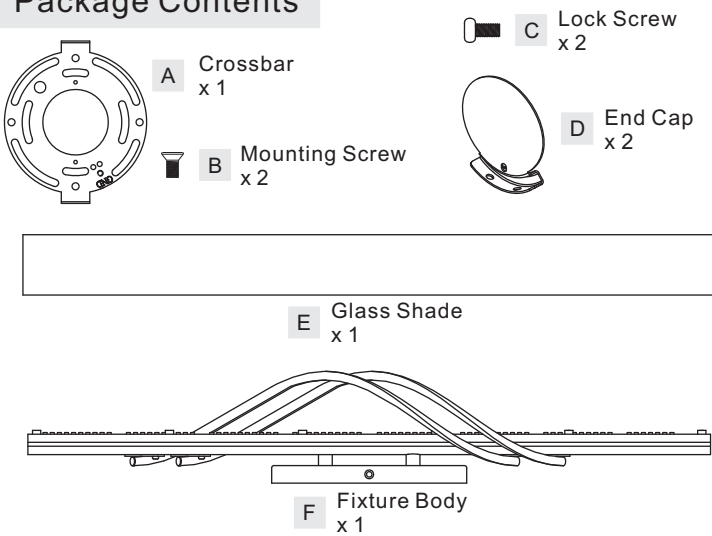

STEP 1 – Install the Glass Shade

- Attach one End Cap (D) to one end of the Fixture Body (F) and secure with one Lock Screw (C). Hand tighten until snug with screwdrivers.
- Place the Shade (E) onto the Fixture Body (F) and attach another End Cap (D) to another end of the Fixture Body (F). Secure with the Lock Screw (C) and hand tighten until snug with screwdrivers.

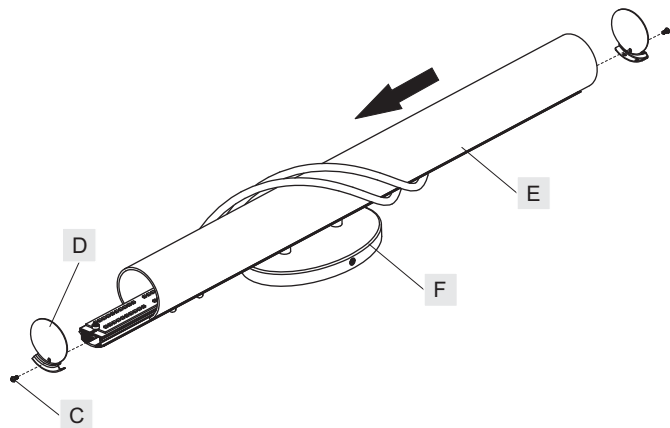

Figure 1

STEP 2 – Install the Crossbar to the outlet box

- Place the supply wires and ground wire through the Crossbar (A). Attach the Crossbar (A) to the outlet box with the head of the green ground screw facing you. Secure it with outlet box screws (not included). Tighten until snug with screwdrivers.

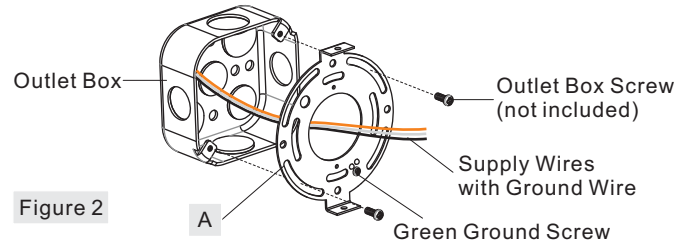

Figure 2

STEP 3 - Wire Connections

- Wrap bare or green ground wire around green ground screw on the crossbar, no less than 2 inches from the end of the wire. Tighten the green ground screw.
- Use standard wire connectors (not included) to make all wire connections. Twist connectors until wires are tightly joined together. Wrap each connection with approved electrical tape and carefully stuff all the connected wires into the Outlet Box.

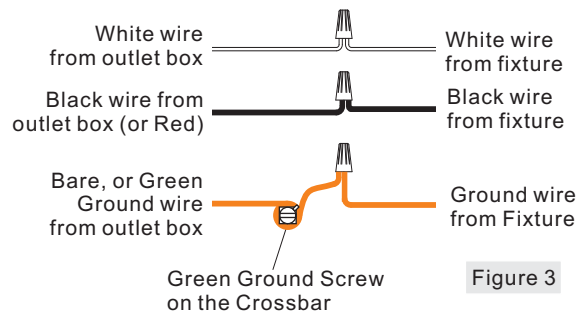

Figure 3

STEP 4 – Install the Fixture Body

- Place the backplate of the Fixture Body (F) onto the Crossbar (A) and secure with Mounting Screws (B). Tighten until snug with screwdrivers.

Your fixture is now assembled and ready to use. Enjoy!

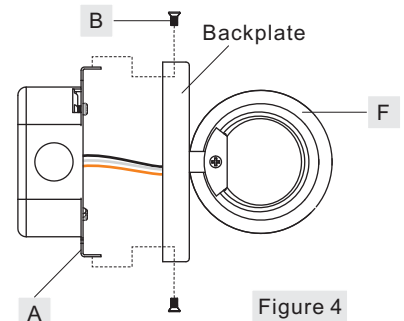

Figure 4

PCSQ8525C

NOTE: ALL DIMENSIONS ARE ROUNDED UP TO THE NEAREST 1/4"

FINISH: POLISHED CHROME

