

Please go to [www.quoise.com](http://www.quoise.com) for product cleaning tips. Go to the **Care + Maintenance** selection.

**Tools Required:** Flathead screwdriver, Phillips screwdriver, pliers, wire cutters, wire strippers, electrical tape, safety glasses.

**Light Source:** Integrated 17W LED

**Compatible Dimmer Switches:** Lutron DVELV-300P or Lutron SELV-300P.

**Estimated Assembly Time:** 20-30 minutes

**Preparation:** Identify and inspect all parts before beginning installation. Check package content list and diagrams below to be sure all parts are present. If any parts are missing or damaged, do not attempt to assemble, install, or operate the fixture. Contact customer service for replacement parts.

### ⚠ Warnings and Cautions

Turn off electricity at circuit breaker or main fuse box before installation. Consult a licensed electrician if in doubt.

These instructions are provided for your safety. It is very important you read them completely before installing the fixture. We strongly recommend that a licensed, professional electrician perform the installation.

### Package Contents

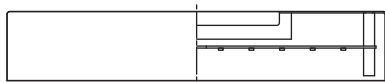

A Fixture Body  
x 1



B Rubber Washer  
x 4



C Lock Screw  
x 4

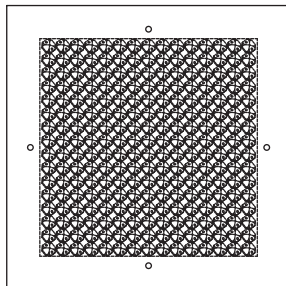

D Glass Panel  
with Crystals  
x 1

### Hardware Contents



AA Crossbar  
x 1



BB Nipple  
x 1



CC Lock Washer  
x 1



DD Hex Nut  
x 1



EE Lock Knob  
x 1

### (Step 2 Continued)

adjust the length of the Nipple (BB) on the Crossbar (AA) by unscrewing the Hex Nut (DD) and the Lock Washer (CC) and then screwing the Nipple (BB) in or out of the Crossbar (AA) until the correct length is achieved. Once the Fixture Body (A) is secure, remove the Lock Knob (EE) and Fixture Body (A) and proceed to step 3.

### STEP 3 - Wire Connections

A. Use standard wire connectors (not included) to make all wire connections. Twist connectors until wires are tightly joined together. Wrap each connection with approved electrical tape and carefully stuff all the connected wires into the Outlet Box.

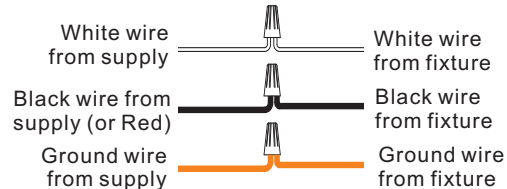

Figure 3

### STEP 1 - Install Crossbar and Nipple

- Secure the Crossbar (AA) to the Outlet Box with Outlet Box Screws (not supplied). Tighten until snug.  
\* Pliers is required on this step.
- Thread the Hex Nut (DD) onto one end of the Nipple (BB). Place the Lock Washer (CC) over the Hex Nut end of the Nipple (BB) and then thread the Hex Nut (DD) into the center lock hole of the Crossbar (AA). Using pliers, thread the Hex Nut (DD) against the Crossbar (AA) and hand tighten until snug.

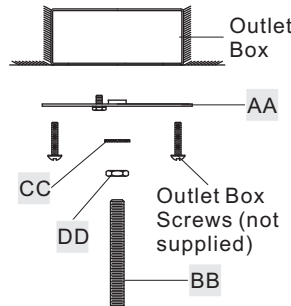

Figure 1

### STEP 2 - Test Fitting Fixture Body to Nipple

- Fit the Fixture Body (A) over the Nipple (BB) on the Crossbar (AA) and secure with the Lock Knob (EE). The Fixture Body (A) should be snug against the ceiling and the Lock Knob (EE). If not,

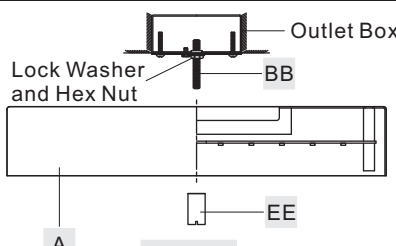

Figure 2

### STEP 4 - Install Fixture Body

- Carefully tuck all wires into the outlet box and position the Fixture Body (A) over the outlet box. Attach the Fixture Body (A) over the Nipple (BB) and secure with the Lock Knob (EE). Hand tighten until snug.

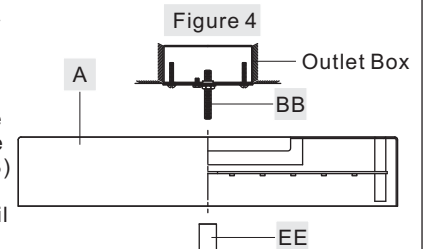

Figure 4

### STEP 5 - Install Glass Panel with Crystals

- Place the Glass Panel with Crystals (D) onto the Fixture Body (A) with Crystals towards the Fixture Body (A). Secure by threading Rubber Washers (B) and Lock Screws (C) into Couplings inside of the Fixture Body (A). Hand tighten until snug.

Your fixture is now assembled and ready to use. Enjoy!

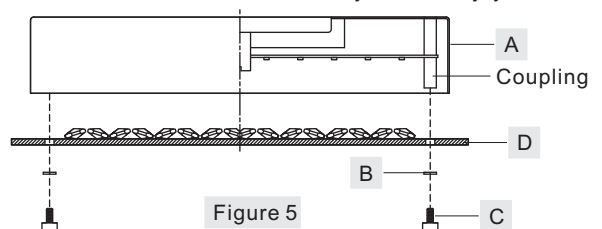
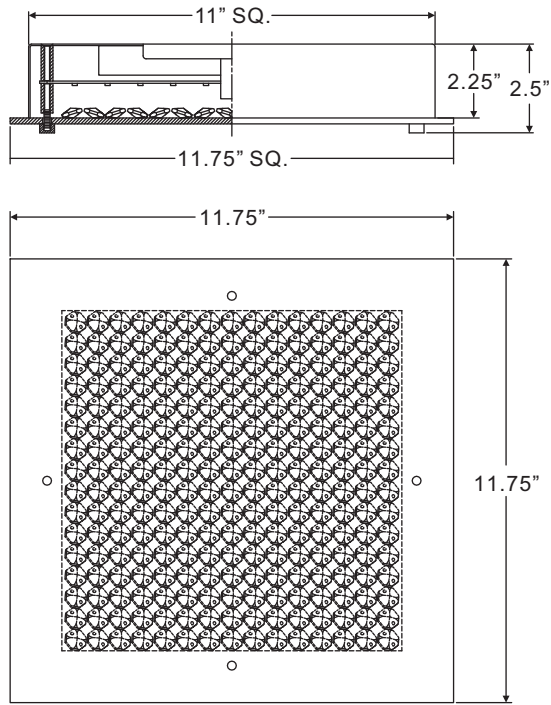
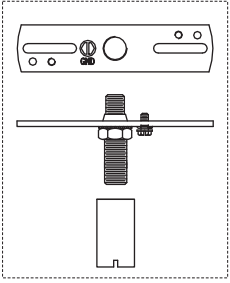

Figure 5

Thank you for purchasing a Quoizel product.  
Need assistance with parts or assembly? Call Quoizel customer service at 1-800-645-3184  
or visit us on-line at [www.quoise.com](http://www.quoise.com)

PCBZ1712C

FINISH: POLISHED CHROME



NOTE: ALL DIMENSIONS ARE ROUNDED UP TO THE NEAREST 1/4"

Thank you for purchasing a Quoizel product.  
Need assistance with parts or assembly? Call Quoizel customer service at 1-800-645-3184  
or visit us on-line at [www.quoise.com](http://www.quoise.com)