

SAFETY INFORMATION

Please read and understand this entire manual before attempting to assemble, install or operate the product.

WARNING

- RISK OF ELECTRIC SHOCK - Before beginning installation, turn off electricity at the circuit breaker box or the main fuse box.
- RISK OF FIRE - Use bulbs specified by the markings and/or labels on the fixture.

CAUTION

- For your safety, read instructions completely before beginning installation.
- If in doubt about electrical installation, consult a licensed electrician.
- Turn off electricity to fixture before replacing the bulb(s).

TOOLS REQUIRED

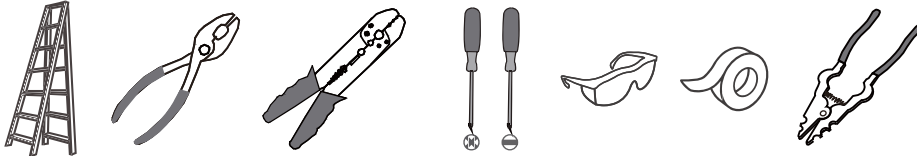

CARE AND MAINTENANCE

- Wipe clean using soft, dry cloth or static duster. Always avoid using harsh chemicals and abrasives to clean fixture as they may damage the finish.

If you need further assistance call Quoizel Customer Care at 1-800-645-3184 (9:00am - 5:00pm EST), or visit us on-line at www.quoizel.com.

PACKAGE CONTENTS

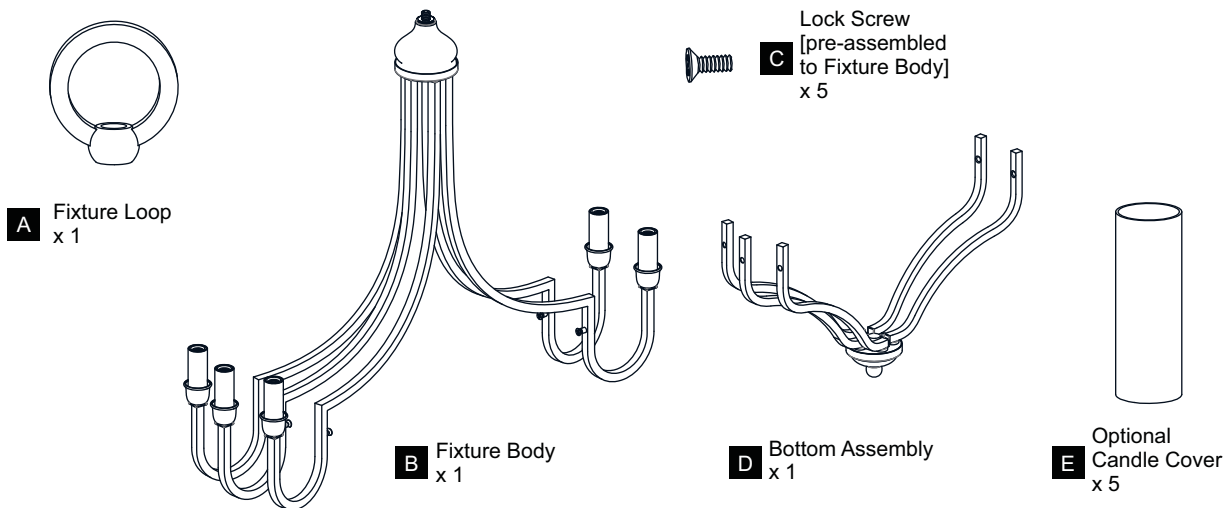

MOUNTING HARDWARE

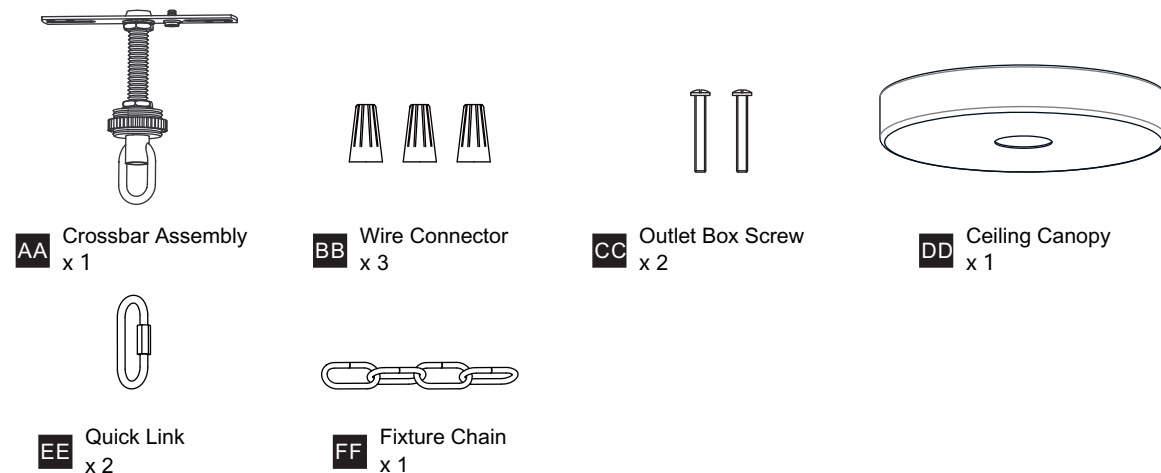

INSTALLATION

1 Unfold Support Arms

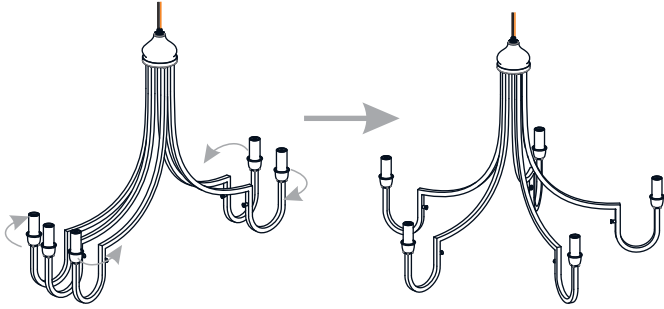

2 Install Bottom Arms

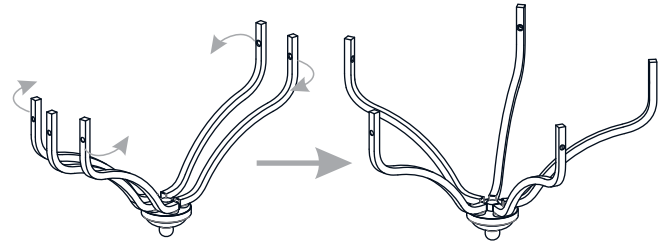

3 Install Bottom Assembly to Fixture Body

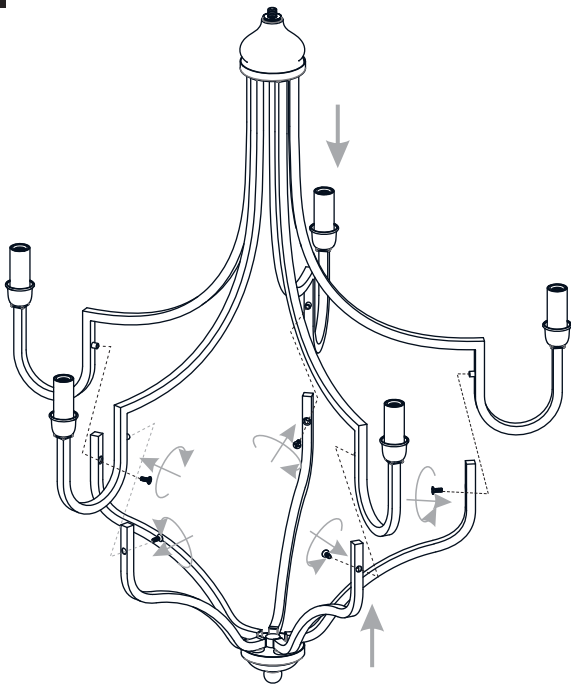

4 Install Fixture Loop

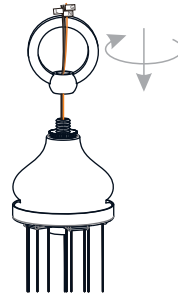

5 Install Crossbar Assembly

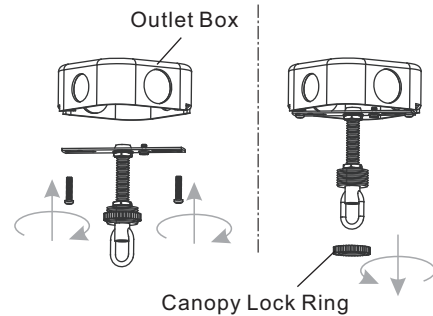

6 Install Fixture Chain

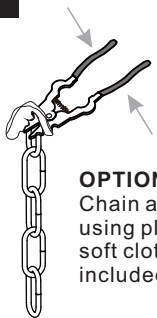

OPTIONAL: Adjust Chain as desired, using pliers and soft cloth (neither included).

Suggested chain length for Ceiling height:
8 feet ceiling: use 3 links of chain and 2 quick links
9 feet ceiling: use 13 links of chain and 2 quick links
10 feet ceiling: use 23 links of chain and 2 quick links.

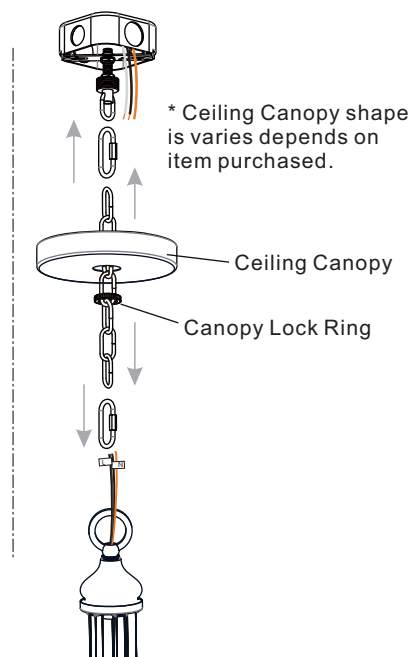

7 Pull Supply Wires

Pull the supply wires with ground wire through the chain alternate links.

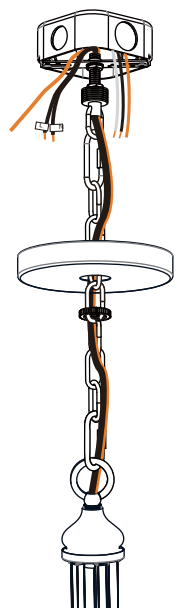

INSTALLATION

8 Wiring

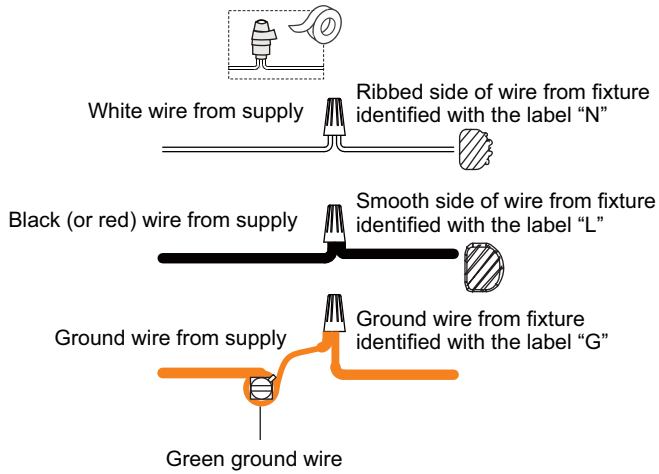

9 Install Ceiling Canopy

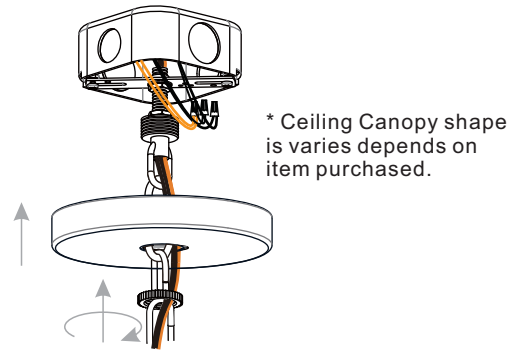

10 Install Bulbs

Install five correct bulbs referring to fixture markings and/or labels for maximum wattage.

Recommended Bulb Type (not included):

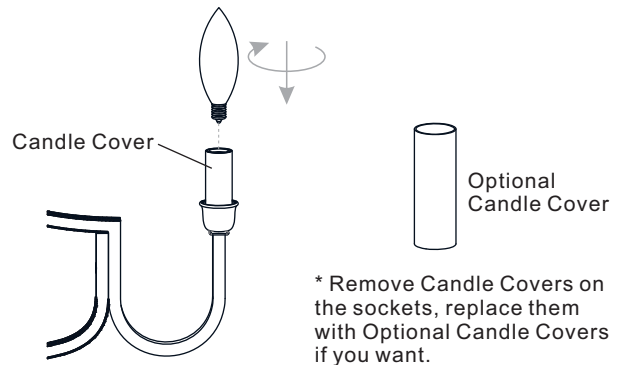
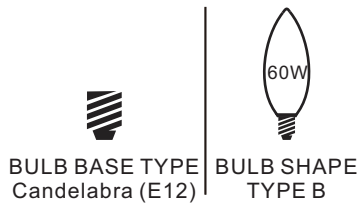

Your installation is now complete! Restore electricity and save this sheet for future reference.