

Installation Instructions

NLCBC

Cobalt Retrofit Reflectors

READ PRIOR TO ATTEMPTING INSTALLATION
ALWAYS TURN OFF MAIN POWER BEFORE INSTALLATION
INSTALLATION SHOULD BE CARRIED OUT BY YOUR LOCAL ELECTRICIAN

⚠ WARNING: Risk of fire or electric shock. Installation of this retrofit assembly requires a person familiar with the construction and operation of the luminaire's electrical system and the hazard involved. If not qualified, do not attempt installation. Contact a qualified electrician.

⚠ AVERTISSEMENT: Risque d'incendie ou de choc électrique. L'installation de cet ensemble de rénovation nécessite une personne familiarisée avec la construction et le fonctionnement du système électrique du luminaire et les risques encourus. S'il n'est pas qualifié, n'essayez pas d'installer. Contacter un électricien qualifié.

⚠ WARNING: Risk of fire or electric shock. Install this kit only in the luminaires that has the construction features and dimensions shown in the photographs and/or drawings.

⚠ AVERTISSEMENT: Risque d'incendie ou de choc électrique. Installez ce kit uniquement dans les luminaires qui ont les caractéristiques de construction et les dimensions indiquées sur les photographies et / ou les dessins.

⚠ WARNING: To prevent wiring damage or abrasion, do not pinch or damage expose wiring during installation. Keep away from to edges of sheet metal or other sharp objects

⚠ AVERTISSEMENT: Pour éviter d'endommager ou d'abrasion le câblage, ne pas pincer ou endommager le câblage pendant l'installation. Tenir à l'écart des bords de la tôle ou d'autres objets tranchants

⚠ WARNING: Risk of fire or electric shock. Do not alter, relocate, or remove wiring, lampholders, power supply, or any other electrical component.

⚠ AVERTISSEMENT: Risque d'incendie ou de choc électrique. Ne modifiez pas, ne déplacez pas ou n'enlevez pas le câblage, les douilles de lampe, l'alimentation électrique ou tout autre composant électrique.

DO NOT MAKE OR ALTER ANY OPEN HOLES IN AN ENCLOSURE OF WIRING OR ELECTRICAL COMPONENTS DURING KIT INSTALLATION.

THIS RETROFIT KIT IS ACCEPTED AS A COMPONENT OF A LUMINAIRE WHERE THE SUITABILITY OF THE COMBINATION SHALL BE DETERMINED BY AUTHORITIES HAVING JURISDICTION.



PACKAGING CONTENTS

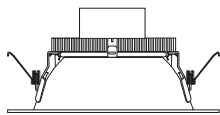

A.



B.



- a. Male Ideal® connector
- b. LED Lamp Replacement Marking Sticker



HOUSING DIMENSIONS

	4"	5"	6"
Height	5-1/2"	6"	5-1/2"
Width	4-1/8"	5-3/8"	6-1/8"

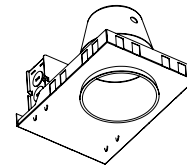

New Construction

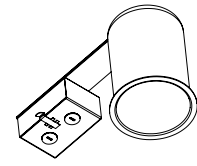

Remodel

Install this kit only in luminaires that have the construction features and dimensions described in these instructions, and where the input rating of the retrofit kit does not exceed the input rating of the luminaire.

Refer to correlation label of luminaire and/or specification sheet at www.NoraLighting.com

Installation Instructions

NLCBC

Cobalt Retrofit Reflectors

READ PRIOR TO ATTEMPTING INSTALLATION
ALWAYS TURN OFF MAIN POWER BEFORE INSTALLATION
INSTALLATION SHOULD BE CARRIED OUT BY YOUR LOCAL ELECTRICIAN

INSTALLATION INTO EXISTING HOUSING

⚠️ TURN OFF MAIN POWER BEFORE INSTALLATION

1. Remove existing trim and light bulb from the recessed housing to reveal the medium base socket. If applicable, remove socket from plate.
2. Place provided LED Lamp Replacement Marking Sticker inside the housing where visible to installer.
3. Cut medium base socket cable off existing housing and connect wires maintaining polarity using the provided male orange connector.
4. NLCBC-4 & NLCBC-5: Connect luminaire and squeeze friction blades on reflector and carefully push fixture into the housing.
NLCBC-6: Connect luminaire and squeeze torsion springs on reflector and insert into holder in the housing.

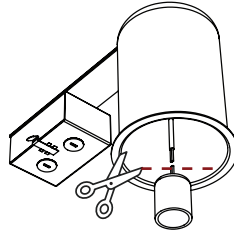

Cut medium base socket

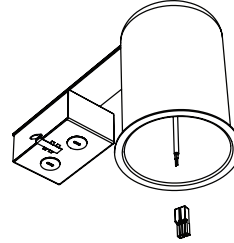

Install male quick connect

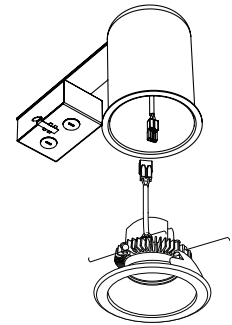

Connect luminaire and install

INSTALLATION INTO DEDICATED LED HOUSING

⚠️ TURN OFF MAIN POWER BEFORE INSTALLATION

1. Connect luminaire's connector to quick connect of Nora's LED dedicated housing.
1. NLCBC-4 & NLCBC-5: Squeeze friction blades on reflector and carefully push fixture into the housing.
NLCBC-6: Squeeze torsion springs on reflector and insert into holder in the housing.
1. Carefully route wires into fixture and push fixture up flush to ceiling surface.

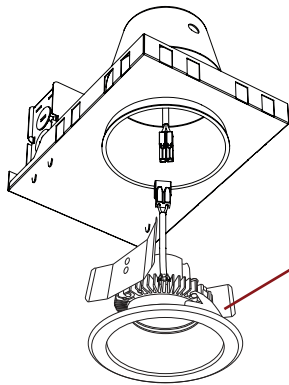

Squeeze friction blades on both sides of the fixture.

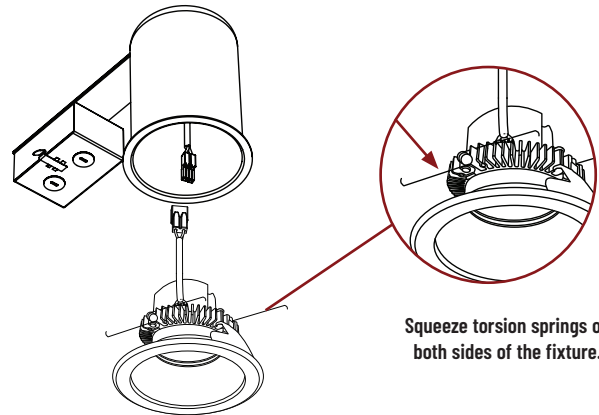

Squeeze torsion springs on both sides of the fixture.

Installation Instructions

NLCBC

Cobalt Retrofit Reflectors

READ PRIOR TO ATTEMPTING INSTALLATION
ALWAYS TURN OFF MAIN POWER BEFORE INSTALLATION
INSTALLATION SHOULD BE CARRIED OUT BY YOUR LOCAL ELECTRICIAN

EMERGENCY CONNECTION (NLCBC-XXX/EM)

Requires NHIC-xLMRAT/6WEM or NHRIC-xLMRAT/6WEM housing

OPTIONAL LE4
0-10V DIMMING

