

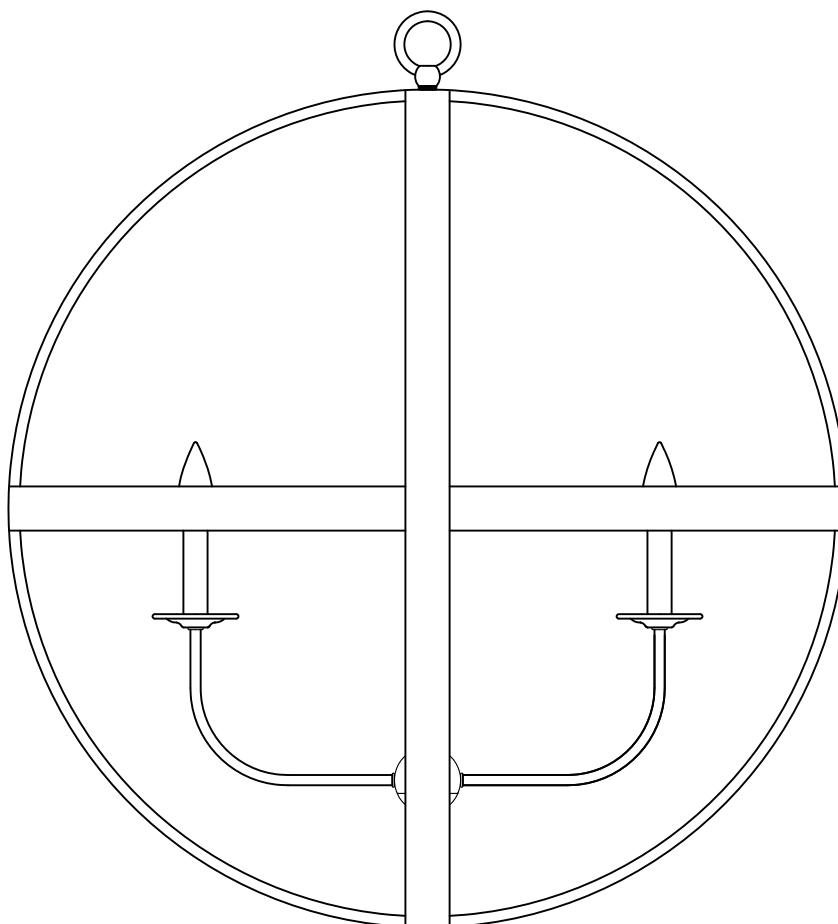

PRODUCT NAME: Compass 6-Light Pendant
ITEM NUMBER: 27576

Please consult a qualified electrician for hanging fixture and wiring.



Bulb (not included): 6*60W E12 Bulbs

IMPORTANT: Turn off the power at the main fuse or circuit breaker box before starting installation

Locate all hardware & components before discarding packaging

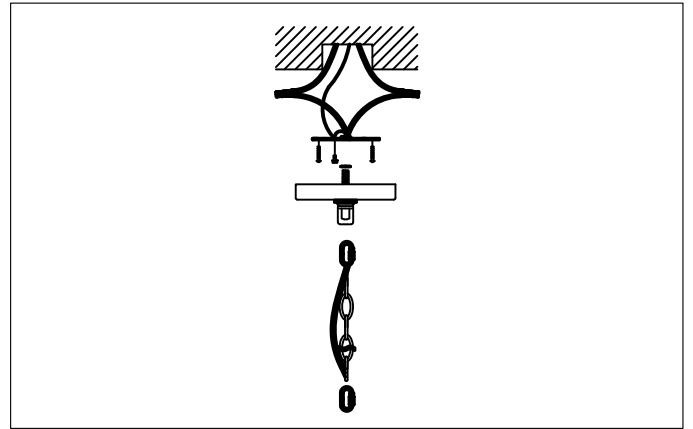
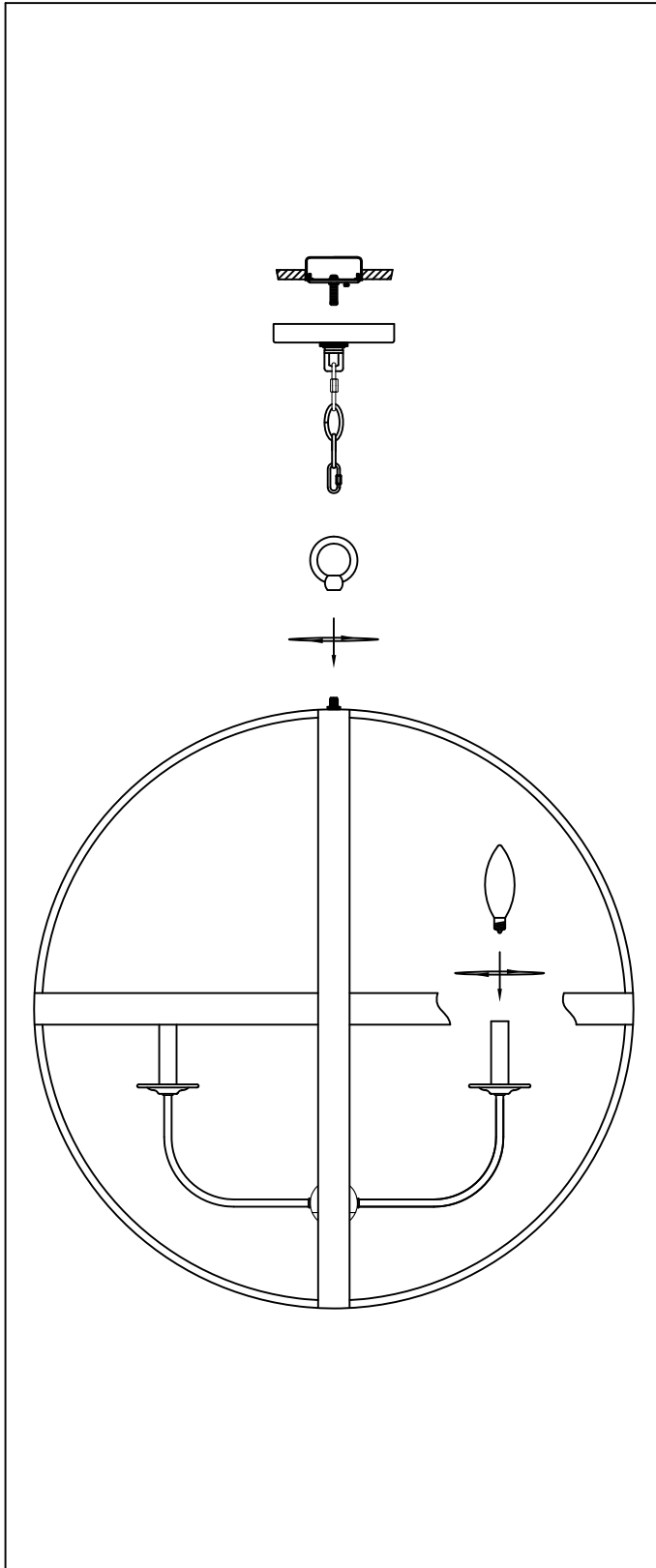

1. Remove mounting bracket from fixture and install to electrical box.
2. Run wire through top loop and install.
3. Attach appropriate amount of chain to loop to achieve desired mounting height. Thread wire through every 3rd loop of chain.
4. Attach fixture to canopy using chain connectors at the beginning and end of the chain. Connect to top loop and canopy.
5. Wire fixture to wires in outlet box. Copper wire is for Ground.
6. Press canopy up to ceiling and secure with ball nuts.

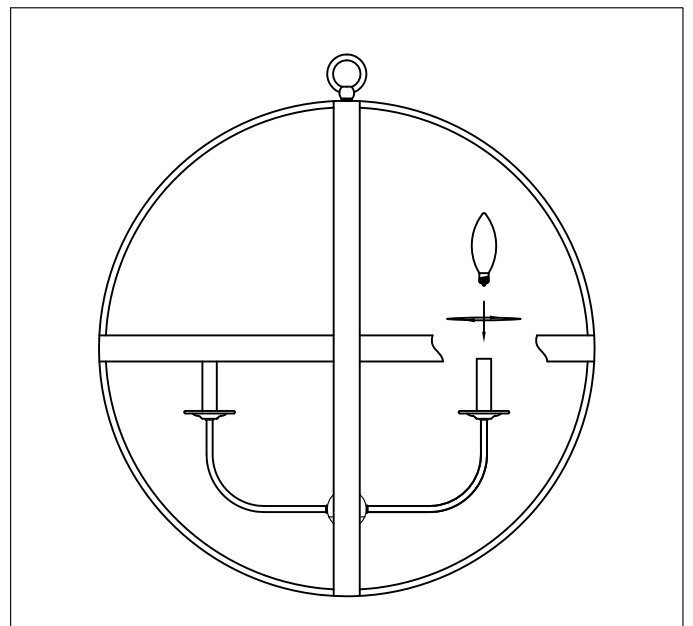

7. Install 6 max 60W E12 bulbs into socket.

Cleaning & Care:
Clean with soft cloth and a mild detergent.
Do not use abrasive cleaner