

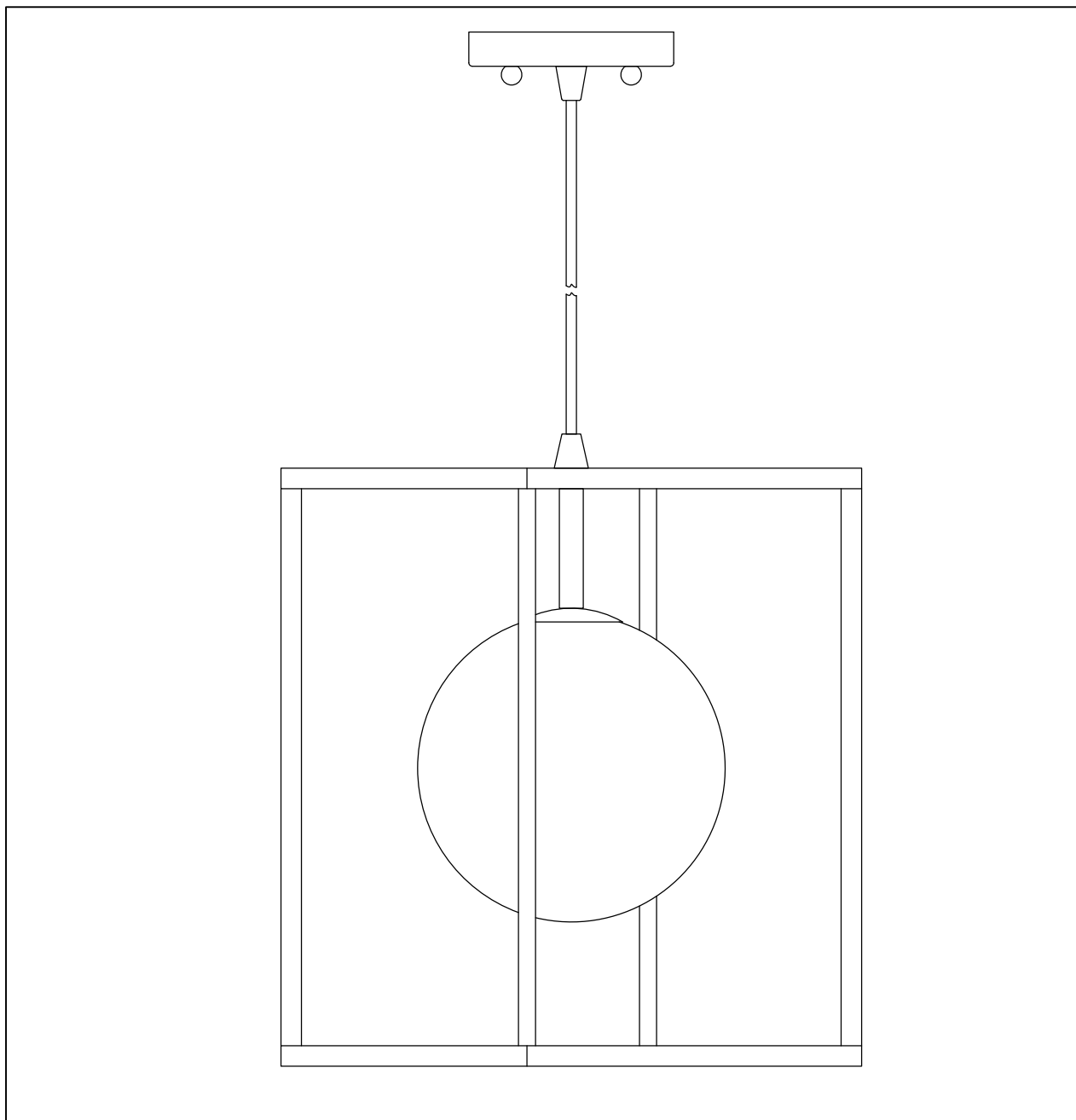

PRODUCT NAME: Fluid LED 1-Light Pendant
ITEM NUMBER: 11361

Please consult your electrician for hanging fixture and wiring.



Bulbs (Included): G9 1*4W

IMPORTANT: Turn off the power at the main fuse or circuit breaker box before starting installation

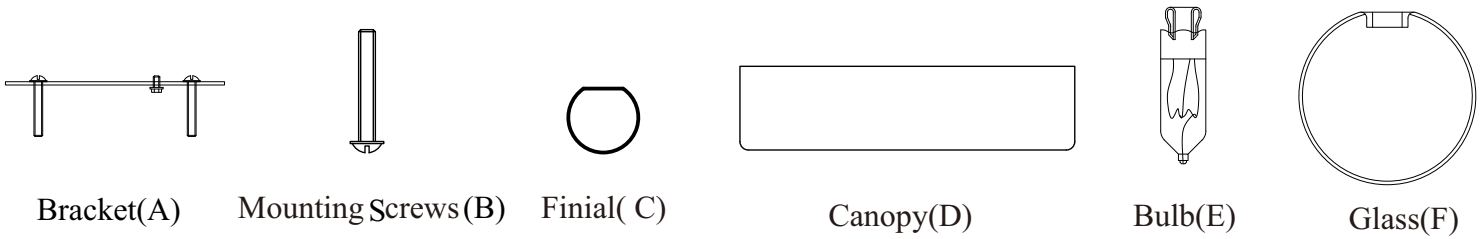

Locate all hardware & components before discarding packaging

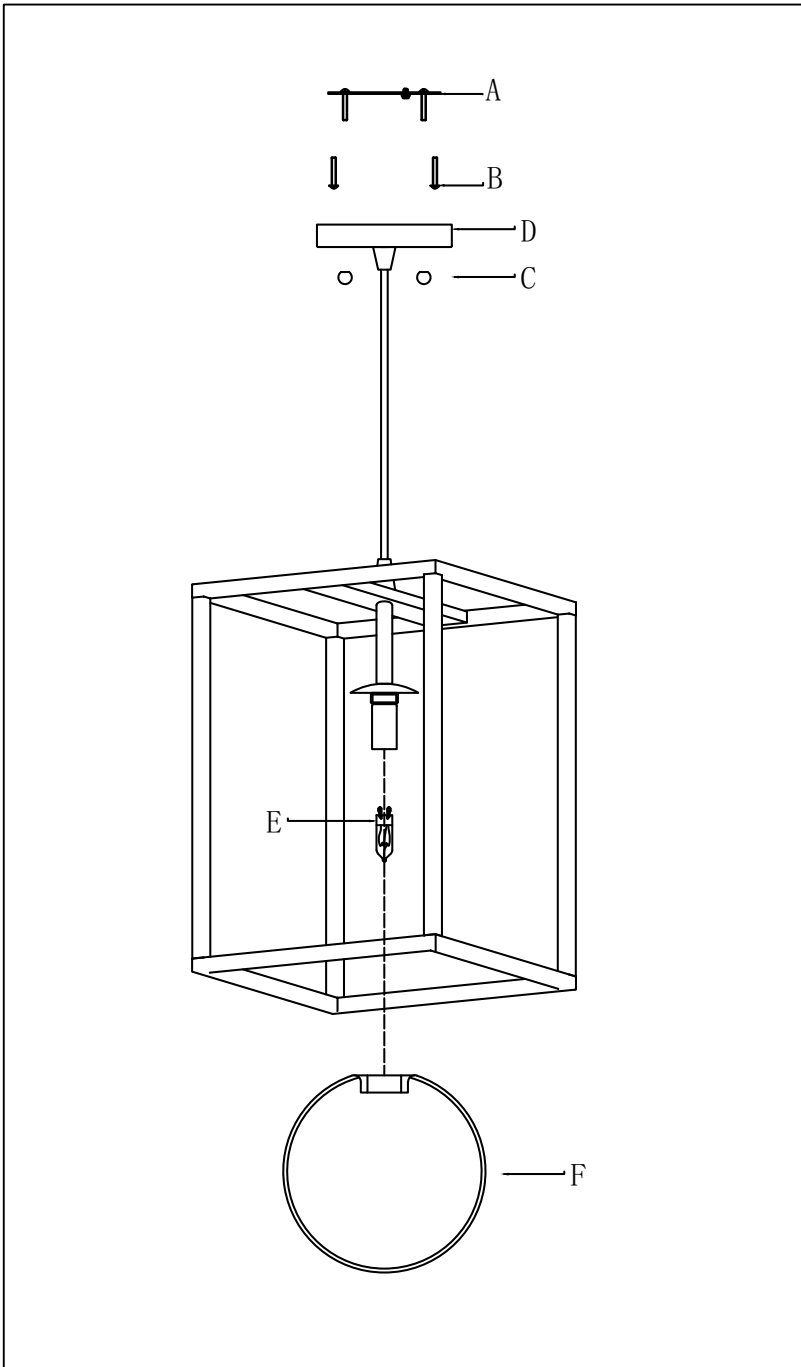

Cleaning & Care:
Clean with soft cloth and a mild detergent.
Do not use abrasive cleaner.

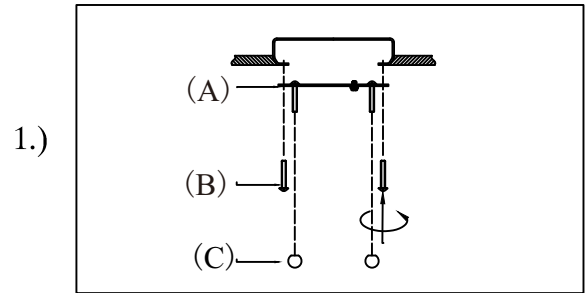

Step1 :Remove mounting bracket from fixture and install to electrical box.

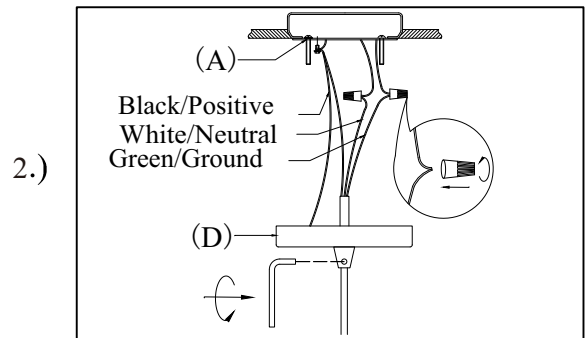

Step2 :Adjust wire length to desired mounting height, and tighten strain relief screws to secure. Wire fixture to wires in outlet box. Green wire is for Ground.

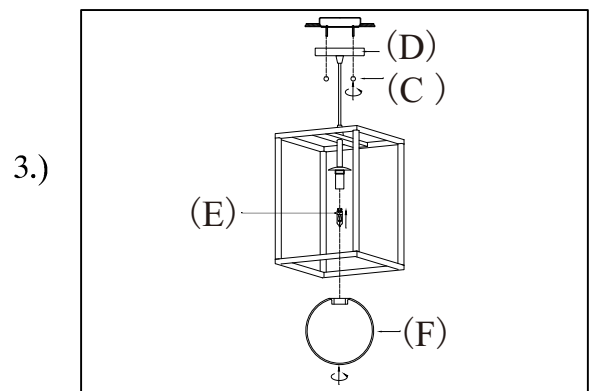

Step3 :Install fixture to the bracket using ball nuts on the canopy. Install bulb provided into socket and thread the glass onto socket.