

INSTALLATION INSTRUCTIONS

Item# P4329-084/647 (New.05/15/2013)

READ AND SAVE THESE INSTRUCTIONS

WARNING! SHUT POWER OFF AT FUSE OR CIRCUIT BREAKER.

AVERTISSEMENT! COUPER LE COURANT AU NIVEAU DES FUSIBLES OU DU DISJONCTEUR.

WARNING

- Risk of shock, do not plug in the unit before assembly is completed.
- **DO NOT EXCEED THE MAXIMUM WATTAGE RATING! (Max. 8W). NE PAS DEPASSER LA PUISSANCE NOMINALE MAXIMALE!**
- Before you begin assembly of your new fixture, please follow the instruction manual step by step.

MOUNTING THE LUMINAIRE, PLUG VERSION (Fig. 1). For hardwire go to fig.2

INSTALLATION

1. Use the "keyholes" located on the mounting plate (A) as a template to mark the location of the drywall anchors (B) and pre-drill the holes.
2. Install the drywall anchors (B) into the wall.
3. Align the "keyholes" on the mounting plate (A) to the drywall anchors and secure with wood screws (C).
4. Align the fixture body (E) to mounting plate (A) and secure with screws (D).
5. To secure the cord cover, install the dry wall anchors (G) (provide) then secure the cord cover bracket (H) to the wall using wood screws (I) (provided).
6. Place the cord (K) into the cord cover bracket (H) and snap the cover (J) over the cord (K).
7. Should the movement of the swivel need to be adjusted, use an allen wrench (included) to loosen the top screw of the swivel and then use a screwdriver (not included) to loosen and/or tighten the bottom screw located inside the swivel. When the desired movement is reached, re-install the allen set screw. (Fig. 3)

IMPORTANT SAFETY INSTRUCTIONS

1. This lamp uses a touch switch. Press and release to turn on and/or off. When in the on position, press and hold the touch switch to cycle from dim to bright. Release the switch once the desired brightness is reached.
2. The LED module can be replaced by a qualified electrician without cutting of wire and without damage to any decorative element to which the fixture is attached. See (Fig 2.)
 - a. Shut off the power and remove the head cover (Q) from the lamp head (L).
 - b. Use a screw driver to loosen the screws (P) and remove the module from the white plastic ring (O).
 - c. Un-plug the wire quick connector with LED module (N) for re-lamping. (Note: The LED module should be provided by specified supplier).
 - d. For better heat dissipation the LED module (N) should be installed with the heat transfer material (M) when re-lamping.

Your installation is now complete. Return power to the outlet box and test the fixture.

Note: Illustration (Fig. 1) on this manual is for installation purposes only. It may or may not be identical to the fixture purchased.

Fig.1

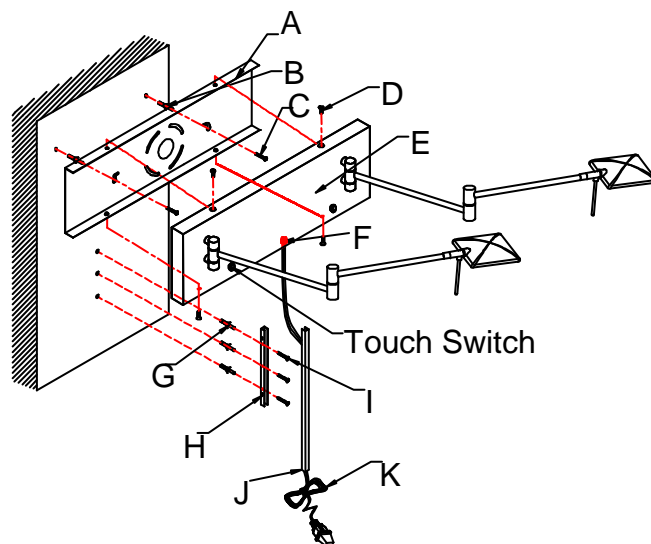

Fig.2

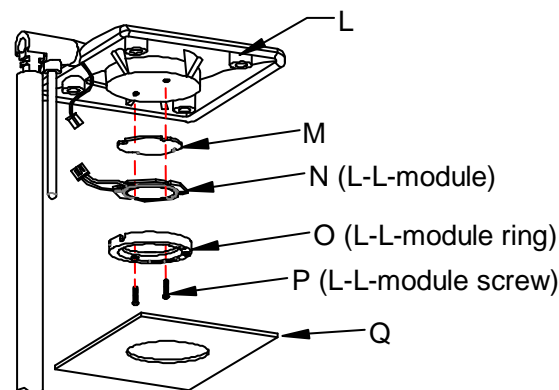
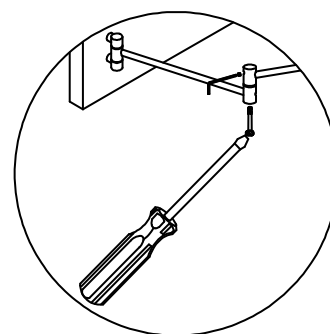

Fig.3



IMPORTANT: FIXTURE SHOULD BE INSTALLED BY A QUALIFIED ELECTRICIAN TO ENSURE PROPER WIRING AND INSTALLATION.

INSTALLATION INSTRUCTIONS

Item# P4329-084/647 (New.05/15/2013)

READ AND SAVE THESE INSTRUCTIONS

WARNING! SHUT POWER OFF AT FUSE OR CIRCUIT BREAKER.

AVERTISSEMENT! COUPER LE COURANT AU NIVEAU DES FUSIBLES OU DU DISJONCTEUR.

MOUNTING THE FIXTURE, HARDWIRE VERSION (Fig. 4 & Fig. 6)

1. Shut off power at the circuit breaker and remove the old fixture including the mounting hardware.
2. Carefully unpack your new fixture and lay out all the parts on a clear area. Take care not to lose any small parts necessary for installation.
3. Remove knockout tabs (1, 2, 3, 4, and 5) from mounting plate (A) with a screwdriver or pliers.
4. Remove screws (F) and metal plate (G) from fixture body (D) by using screwdriver (**not included**). (Fig.6)
5. Loosen the wire connectors located inside the fixture backplate and carefully remove the power cord and bushing.
6. Secure mounting plate (A) to the outlet box using mounting screws (B) (Size: #8-32N*L0.5"). The side of the mounting bracket marked "GND" must face out.

CONNECTING THE WIRES (Fig. 5)

7. Connect the electrical wires as shown in Fig. 5, making sure that all wire connectors are secured. If your outlet has a ground wire (green or bare copper), connect the fixture's ground wire to it.

FINISHING THE INSTALLATION (Fig. 4)

8. Align fixture body (D) to mounting plate (A) and secure with screws (C).
9. Insert plug (E) into the hole in fixture body (D).

Your installation is now complete. Return power to the outlet box and test the fixture.

Note: Illustration (Fig. 4) on this manual is for installation purposes only. It may or may not be identical to the fixture purchased.

Fig. 4

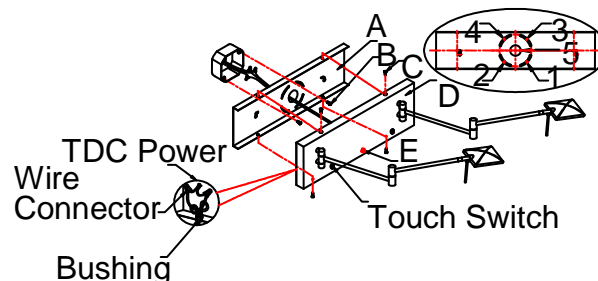

Set# A-021-450105

- Mounting plate
- Ground screw
- Mounting Screw*2

Fig. 5

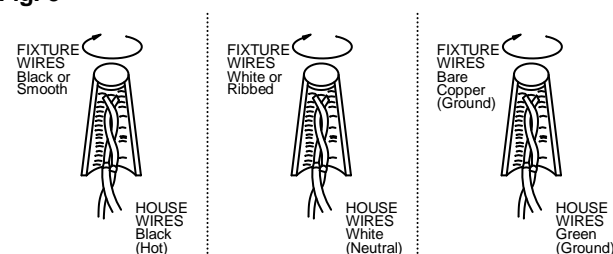
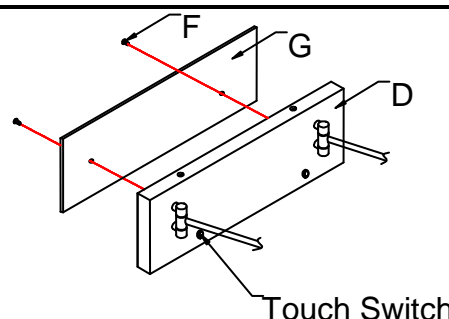

Fig. 6



IMPORTANT: FIXTURE SHOULD BE INSTALLED BY A QUALIFIED ELECTRICIAN TO ENSURE PROPER WIRING AND INSTALLATION.