

Features

- Traditional styling
- Integrated air gap
- Right-side lever handle
- 9-9/16" (243 mm) spout height
- 5-9/16" (141 mm) spout reach
- Faucet spout rotates 360° and offers clearance for filling glasses and pitchers
- 1.5 gpm (5.7 lpm) maximum flow rate at 60 psi (4.14 bar)
- RO (reverse osmosis) compatible
- Works with KOHLER filtration systems or as a cold water tap
- KOHLER ceramic disc valves exceed industry longevity standards for a lifetime of durable performance

Material

- Premium metal construction
- KOHLER® finishes resist corrosion and tarnishing

Installation

- Single hole

Included Components

1329347 Air gap device

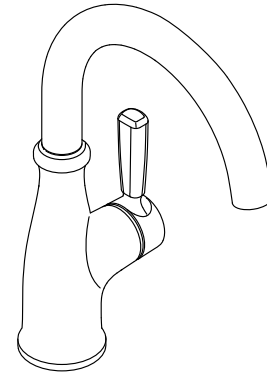

ADA

CSA B651

Codes/Standards

ASME A112.18.1/CSA B125.1

NSF/ANSI/CAN 61

NSF/ANSI/CAN 372

All applicable US Federal and State material regulations

DOE - Energy Policy Act 1992

California Energy Commission (CEC)

ADA

ICC/ANSI A117.1





CSA B651

KOHLER® Faucet Lifetime Limited Warranty

See website for detailed warranty information.

Available Colors/Finishes

Color tiles intended for reference only.

Color	Code	Description
	CP	Polished Chrome
	VS	Vibrant® Stainless
	2BZ	Oil-Rubbed Bronze
	BL	Matte Black
	2MB	Vibrant® Brushed Moderne Brass

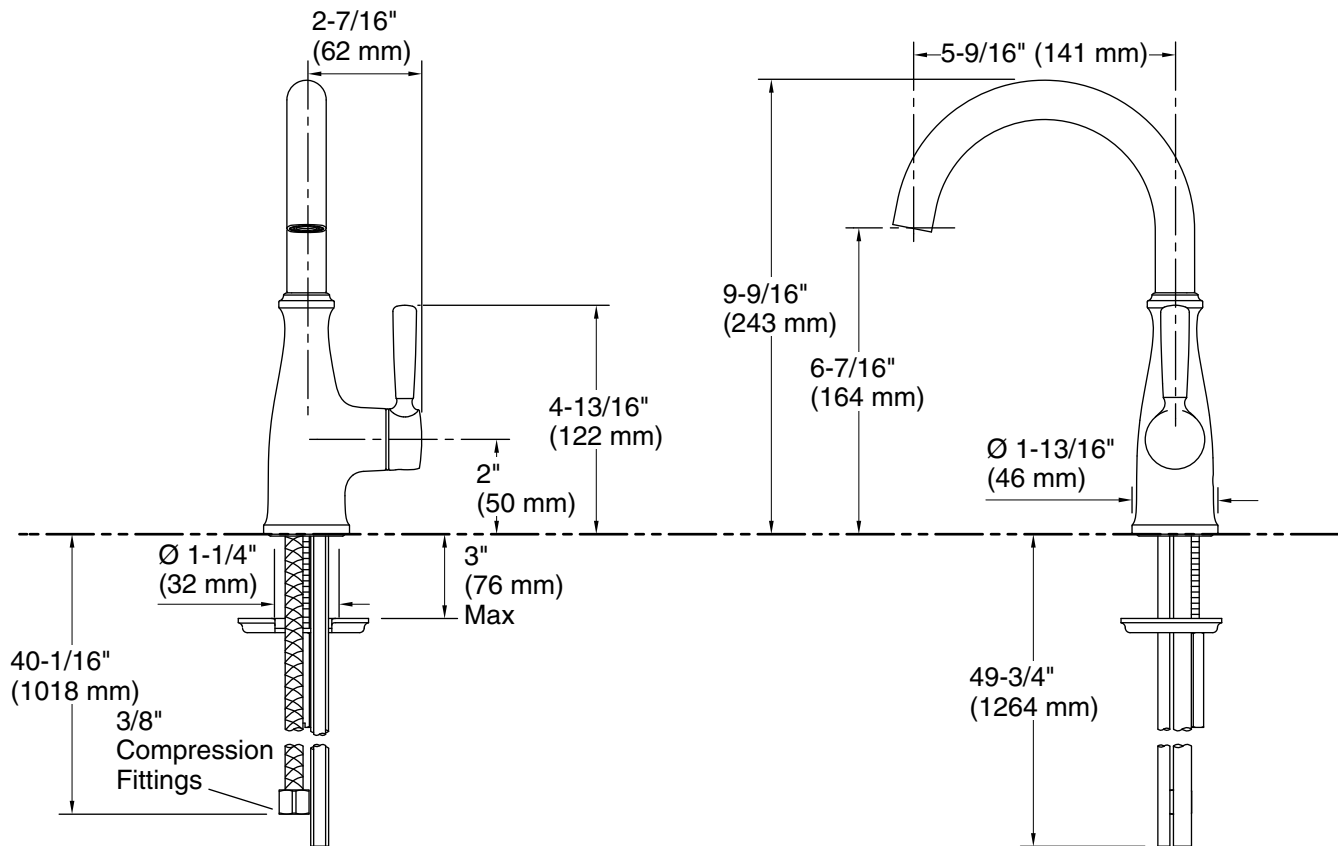

Technical Information

All product dimensions are nominal.

Notes

Install this product according to the installation instructions.

ADA, CSA B651 compliant when installed to the specific requirements of these regulations.