

### Features

- Spacious design accommodates up to two bathers.
- Molded lumbar supports and armrests offer extra comfort while bathing.

### Material

- Acrylic

### Installation

- Drop-in or corner alcove.

### Additional Hydrotherapy Options

- Soaking Bath - 1161-0
- Whirlpool - 1160-0
- Whirlpool + heater - 1160-H

### Recommended Products/Accessories

- K-1491 Bath/Whirlpool Pillow
- K-11677 Bath Drain
- K-1601 Bath/Whirlpool Footstop
- K-7213 27" Cable Bath Drain
- K-7214 27" Cable Bath Drain
- K-7259 Clearflo Bath Drain
- K-37382 45" Rough-in Cable Bath Drain



### Codes/Standards



CSA B45.5/IAPMO Z124  
UL 1795

### KOHLER® Plastic Baths and Receptors Lifetime Limited Warranty

See website for detailed warranty information.

### Available Colors/Finishes

*Color tiles intended for reference only.*

Color	Code	Description
	0	White
	96	Biscuit
	47	Almond

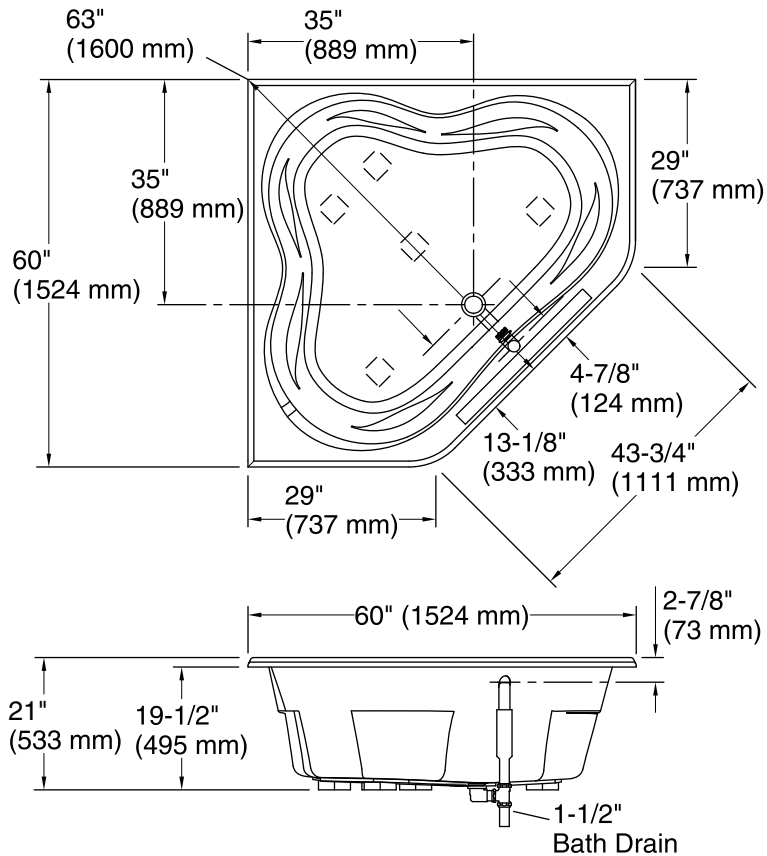

No change in measurements if connected with drain illustrated. (K-11677)

 Recommended Faucet Location

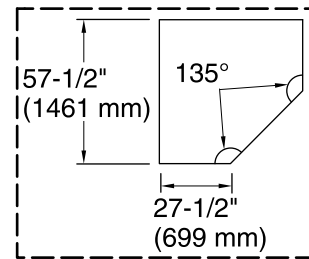

**Drop-In Rim Style  
Cut-Out Detail**

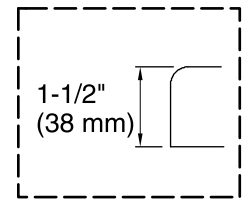

**Drop-in Rim Detail**

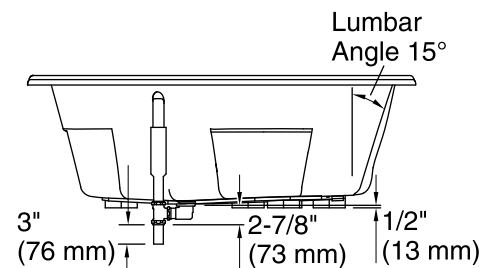

### Technical Information

All product dimensions are nominal.

Installation:	Drop-in
Drain location:	Center
Basin area, bottom:	52" x 38-3/4" (1321 mm x 984 mm)
Basin area, top:	61" x 46-1/4" (1549 mm x 1175 mm)
Weight:	91 lbs (41.3 kg)
Minimum floor load:	38 lbs/ft <sup>2</sup> (185.5 kg/m <sup>2</sup> )
Water depth:	15" (381 mm)
Water capacity:	96 gal (363.4 L)
Cutout:	Drop-in, 57-1/2" x 27-1/2" (1461 mm x 699 mm)

### Notes

Measure your actual product for rough-in details. Install this product according to the installation instructions.

The hot water supply should be 70% of the capacity of the bath or greater. Installations will vary.

If installing a rim-mount faucet, make sure there is no interference above or below the deck before drilling any holes.