

PRODUCT AND INSTALLATION MANUAL

Estate Home and Commercial Water Filtration Systems for 2.0" incoming line size

MODEL NUMBERS:

Home and Commercial Water Filtration & Conditioning Systems:

EWS-1665-2, EWS-CC-2472-2

Home and Commercial Water Filtration Systems:

CWL-1665-2, CWL-CC-2472-2



ENVIRONMENTAL WATER SYSTEMS®
Quality Water Filtration Crafted in the USA Since 1987.

WWW.EWSWATER.COM

Retain this Product & Installation Manual
for Helpful Information

Please Register Your System

Revised 12/01/2017 V: N.1.0



SIMPLE STEPS FOR A CORRECT INSTALLATION AND A HAPPY CUSTOMER

1. Set up system and install it on the main water supply coming into the home [Page 7-8](#)

2. Set up a bypass (see illustration →) and use corrugated flexible stainless or some other flexible piping to make the plumbing connections [Page 8-10](#)

3. Install a proper drain line with an air gap [Page 11](#)

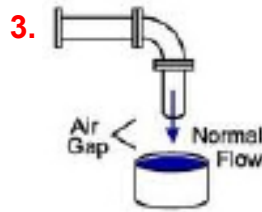

4. Plug in the system into a standard outlet and set the time of day [Page 12-13](#)

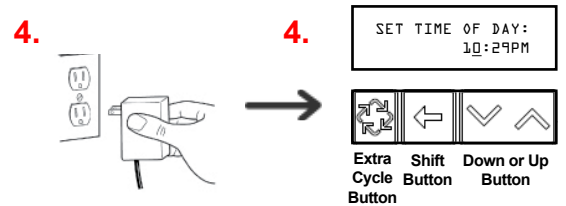
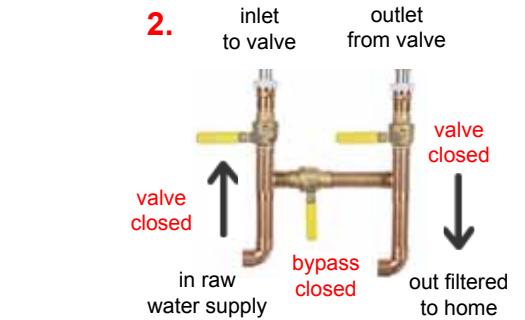

5. Before opening inlet and beginning start up procedure - you must clear the plumbing lines and connections. [Page 13](#)

- 1.** keep inlet & outlet closed,
- 2.** turn on main water supply
- 3.** go to a tub (best) or nearest faucet (remove aerator)
- 4.** run water to clear plumbing lines
- 5.** avoid debris from entering installed system

6. After # 5, Open valve on the incoming line slowly to fill the tank and begin the start up procedure. Keep bypass and outgoing valve closed [Page 13](#)

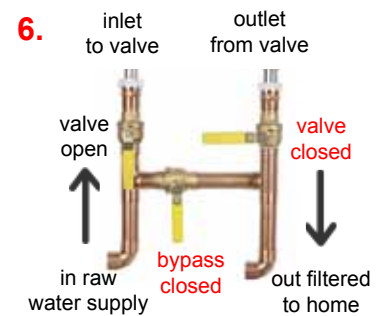

7. Allow system to start itself up and self clean the filtration media [Page 14](#)

8. Open valve on the outgoing line (keep bypass closed) and put system in service position and flush water throughout the house, flush toilets, run tubs, replace ice and drain water heater if needed. [Page 15-16](#)

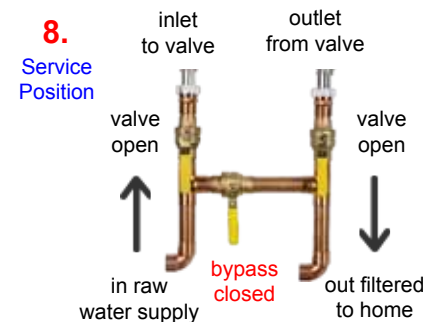

Avoid Problems and Callbacks and Create Happy Customers



SIMPLE STEPS FOR A CORRECT INSTALLATION AND HAPPY CUSTOMER	2
INSTALLATION DIMENSIONS FOR 1665-2 AND 2472-2 SYSTEMS	4
ASSEMBLY INSTRUCTIONS	5
IMPORTANT SAFETY INFORMATION – All Systems	
Instructions Before Using	6
LOCATION AND SETUP - All Systems	7
Unpacking and Inspection	
Where to Install the System	
Drain Location	
Outside Installation (where applicable)	
INSTALLATION INSTRUCTIONS - All Systems	
Plumbing Connections and Bypass	8
Drain Line	11
Electrical Connection	12
START-UP PROCEDURES - All Systems	
Set the Time of Day	13
Tank Fill Slowly	13
Flushing the System Procedure	14
Last Steps Before Leaving the System	15
Repeat Flushing (if needed)	
Open Outlet Side of Bypass	
System Ready for Use	
Run Water throughout the Home	
Product Blow-Out (for illustration purposes)	17
Valve Parts Blow-Out	18
Warranty	19
Back Cover with EWS Contact Information	20

For additional installation information and videos, troubleshooting and questions & answers - please visit www.ewswater.com or email the EWS crew @ customerservice@ewswater.com or call us @ 702.256.8182 during normal business hours, Monday through Friday from 8am to 4:30pm pacific standard time

COMPLIANCES, CALIFORNIA COMPLIANCES, PRODUCT GUIDELINES, FACTORY PREPARATION, PRODUCT PERFORMANCE AND GENERAL TERMS AND STANDARD CONDITIONS OF SALE ARE AVAILABLE UPON REQUEST OR PUBLISHED ON WWW.EWSWATER.COM

For Illustration Purposes Only:

On-Site Assembly Required

Due to shipping weight for all larger systems, tank, all tank contents and valve must be assembled on site. Please review the simple steps for proper assembly.



Pictured: EWS-1665-2, CWL-1665-2

depth: minimum 24" needed for proper installation



Pictured: EWS-CC-2472-2, CWL-CC-2472-2
depth: minimum 28" needed for proper installation



For Illustration Purposes Only:

This is an example of 3 valve bypass using corrugated flexible stainless to make the final connections with the valve. Configuration may vary

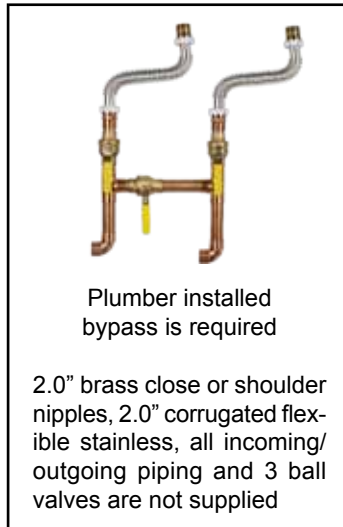

Plumber installed bypass is required

2.0" brass close or shoulder nipples, 2.0" corrugated flexible stainless, all incoming/outgoing piping and 3 ball valves are not supplied

CAUTION:

All measurements are approximates and system heights may have variances up to 2".

***Not Supplied:**

Due to variations in installations, length and sizing needed for pipe connections to and from the system (see flexible requirement) and drain line are not supplied

Flexible Connections Required:

Stainless steel corrugated water connectors, PEX or PVC Sch 40 have a flexible capability that may assist with issues where the rough and finish measurements are slightly off or where pressure surges/spikes or back pressure occur. This flexible connection may prevent tank and valve issues where rigid or hard pipe create problems over time. This is a requirement of the tank manufacturer and is stated on the label affixed to every tank. Perform all plumbing according to state or local codes.

Drain Line Air Gap Required and Spring Check Highly Recommended:

Please see information for proper drain line installation in the Product and Installation Guide



For Illustration Purposes Only: Corrugated flexible stainless not supplied

Complete setup, install and startup of these systems can be found in this Product and Installation Guide

CAUTION: If installing other equipment in addition to this System - Contact customer service for proper order of installation

CHECK TO SEE IF YOU HAVE ALL THE BOXES BEFORE ASSEMBLY - BELOW IS THE BOX COUNT FOR EACH SYSTEM

Model #'s EWS-1665-2 and CWL-1665-2 should have 7 boxes.

- 1 Box - Tall with 16" x 65" Tank with a Capped 1-1/2" Riser Tube (or ICN (3) Riser Manifold - EWS Series only) inside and Tank Wrap
 - 1 Box (master carton) contains Valve, Valve Screen, and Service Manual
 - 1 Box contains 50 lbs. underbed (pea gravel material specific to this system for filtration and flow rate) with Black Funnel
 - 4 Boxes containing 1 cubic foot each (35 lbs. each box) of EWS' proprietary GAC Media
- 7 Total

Model #'s EWS-CC-2472-2 and CWL-CC-2472-2 should have 13 boxes.

- 1 Box - Tall with 24" x 72" Tank with a Capped -1/2" Riser Tube (or ICN (6) Riser Manifold - EWS Series only) inside and Tank Wrap
 - 1 Box (master carton) contains Valve, Valve Screen and Service Manual
 - 1 Box contains 50 lbs. underbed (pea gravel material specific to this system for filtration and flow rate) with Black Funnel
 - 10 Boxes containing 1 cubic foot each (35 lbs. each box) of EWS' proprietary Chloramine Reduction Media (CRM)
- 13 Total

simple steps for proper assembly - no tools required

1. Tank - remove from the tall box.

Caution: Riser (or ICN Riser Manifold - EWS Series only) is already in the Tank. Do not remove and be careful not to damage.

Note: You will need to center the riser as you fill the tank with filtration media in Step 5.

2. Tank will be heavy once filled so move it to the installation and main water line connection location beforehand.

3. Keep Riser Capped to cover opening of the clean Riser to prevent filling down the tube. Heavy-duty tape can also be used.

4. Place or adjust Capped Riser Tube in the center of the Tank.

Caution: Riser rests at the bottom and center of Tank. Do not press down. Follow loading instructions - step # 5, A-B.

5. Load the Tank in the following order:

A: 1st - find the Box which contains 50 lbs. of underbed (grey pea gravel) with the Black Funnel and load all materials until box is empty.

Caution: Slowly fill and make small adjustments as needed to make sure Riser Tube is straight up and down and centered in Tank.

B: Next - find the next 4 (1665 systems) or 10 (2472 systems) boxes with pre-measured filtration media. This material is black and granular and the boxes weigh 35 lbs. each. Empty all the contents of each box into the Tank.

Caution: Slowly fill and make small adjustments as needed to make sure Riser Tube is straight up and down and centered in Tank.

Caution: Media is dusty. Do not inhale. Work in area with good ventilation and/or take preventative measures.

Note: Top 1/3 of the Tank should be empty. This is called freeboard for the proper backwashing of the system

6. Once the Tank is loaded, remove the Cap (or tape) from the top of the Riser Tube.

7. Installation of the Valve onto the Tank:

From master carton remove Valve and Valve Screen.

A: Connect Valve Screen to the bottom of the Valve before connecting Valve to the Tank

B: Make sure the top of the Tank and Tank threads are clean of any debris or materials from Steps 1 through 6.

C: Center Riser Tube where it fits up and into the center & bottom of the Valve. The Valve Screen at the bottom of the Valve will help center and guide the Riser Tube into the proper position. Back off the installation if resistance occurs and retry until Riser fits up and slips into position without any issues.

Warning: Do not force Riser into the bottom of the Valve. Riser should be straight and centered and should fit snugly into that position. A Riser that is forced to fit, bent or off-center may prevent a proper fit into the valve, crush the lower screen or fail under pressure. The result would be the media material contained in the Tank would enter the plumbing system.

D: Install the Valve onto the Tank by turning clockwise. Be careful not to cross-thread the Valve onto the Tank.

CAUTION: DUE TO THE WEIGHT OF VALVE - DO NOT CROSS-THREAD THE VALVE ONTO THE TANK

8. Please place Tank Wrap around Tank. Tighten across the Tank using the velcro strips.

CONTINUE TO THE INSTALLATION & FOLLOW THE PROPER SETUP, INSTALLATION AND STARTUP PROCEDURES

	<p>CAUTION: Read and follow the information in this manual to minimize the risk of electric shock or personal injury.</p> <p>IMPORTANT! If you are unsure about the installation of your system, contact EWS customer service or consult a professional plumber.</p> <p>IMPORTANT! This system must be installed in compliance with applicable state and local codes, law, and regulations.</p>
---	--

Instructions Before Using

Before beginning installation, read all instructions completely. Then obtain all the materials and tools needed for installation. Handle all components of the system with care. Do not drop, drag or turn components upside down.

WARNING: Failure to setup, install and startup the system correctly in any manner voids the warranty.

CONNECTIONS: Perform installation according to state and local plumbing codes.

REQUIRED: Use of flexible stainless steel connections is required (as code applicable) to connect unit to water supply. Allows flexibility for tank expansion under pressure (see installation section in this manual).

WARNING: Use of teflon tape is the only sealant to be used on threaded drain and adaptor connections. Do not use pipe dope or pipe joint compound.

EXISTING PLUMBING: Condition of existing plumbing should be free of lime &/or iron buildup. Pipe(s) and/or water heaters should be replaced if any heavy buildup exists. Pre-existing conditions will effect the performance of this system.

ELECTRICAL: All Systems in this guide (USA versions) use 12 volt transformer for electrical power. Always use the supplied power cord and transformer. Plug power cord into a standard 110/115/120 volt, grounded and unswitched outlet. If outside, follow code for protected outlet and GFI. Be sure electric outlet and transformer do not come in contact with water.

CAUTION: Plumber installed jumper between inlet and outlet connections may be required to maintain the plumbing system ground. Properly ground system to conform with all codes and ordinances.

INSTALLATION LOCATION:

- Install system in a protected area.
- Always connect the system to the main water supply pipe feeding the entire home before the water heater(s).
- Do not install in direct sunlight. Heat from sun may cause damage. Protect from sun, rain, wind, etc.
- See "Where to Install the System" on page 8 of this manual for complete information.

WATER TEMPERATURE:

WARNING: Any water over 110°F, thermal expansion of any water heater or where any hot or heated water comes back or flows through the system over 110°F at any time voids the warranty. Do not expose system to freezing temperatures which causes equipment damage and voids the warranty.

PRESSURE: Minimum inlet water pressure is 20 psi. Maximum inlet water pressure is 75 psi. Use (PRV) pressure reducing valve if necessary to prevent high pressure and problem pressure surges above 75 psi.

WARNING: Pressure exceeding, surging or spiking above 75 psi or any negative pressure voids the warranty.

	<p>CAUTION:</p> <ul style="list-style-type: none"> • Do not use with water that is microbiologically unsafe or of unknown quality without adequate disinfection. Well water needs to be properly and completely tested before the specification of any filtration and treatment system(s). • Test water periodically to verify that the system is performing satisfactorily.
---	---

location and setup

UNPACKING AND INSPECTION - Check the system components for damage or missing parts.

WHERE TO INSTALL THE SYSTEM

- Place system on the main water supply in order to supply filtered water to the entire home or facility.
- Place the system where you want to install the unit. Whether inside or outside, make sure the unit is level and on a firm base.
- A standard grounded and unswitched 110/115/120v electrical outlet is needed to plug in the transformer. If outlet is over 16 feet away use 18 gauge extension cord to connect up to 100 feet away. Do not exceed 100 feet. Do not cut or splice original equipment.
- Do not install the system where it would block access to the water heater, or access to the main water shutoff, water meter, or electrical panels. Always connect the system prior to the water heater(s).
- Install the system in a place where damage is least likely to occur if any unforeseeable issue arises. System should be in an accessible location and be visible in order to visually monitor system and routinely check clock operation and valve controls.

CAUTION: Do not install on a soft water loop or bypass of other water lines where the filtered water will not be available for use. All Whole Home Filtration Systems are designed to filter all the water to the entire home or facility.

CAUTION: Installing other equipment in addition to this System? Softeners (if applicable) always go after the filtration system. Any questions? Please contact EWS for proper order of installation.

NOTE: Can be connected for outside faucets for plants, lawn, pools, spas, and other features. It is not necessary under normal circumstances for any outside application. All Iron Systems will not harm these other features, however there will be more water usage through the system and may not create any additional benefits for those features due to external environmental issues and porous or natural surfaces or materials.

DRAIN LOCATION

- Place the system as close as possible to a vented sewer drain with a "P" trap or some other drain location.
- *Highly Recommended:* Install a non-restrictive spring check valve in drain line within the first 2' of the drain port to prevent possible back flow. (see below when a non-restrictive spring check valve is required)

REQUIRED: Air gap with proper ventilation is a requirement. Similar to any washing machine, this system must have a minimum of a 1" air gap on the drain to prevent back flow of drain water or gases into the system

REQUIRED: Expand drain line to 1" ID *and* install a non-restrictive spring check valve in drain line within the first 2' of the drain port if drain line exceeds 20' in total length, or drain line flows over 5' above the height of the drain port, or if drain line is being routed outside.

CAUTION: Never install drain line smaller than 3/4" in diameter. Never restrict drain line or drain water flow.

- Consider the reuse of drain water as an alternative to simply going down the drain.

Unlike salt or resin systems or softeners which have a brine discharge, all Whole Home Water Filtration Systems drain only filtered water in order to self-clean the filter. Water can go back to a pool for make up water or water a yard, trees and plants. You can use this filtered drain water in many ways.

Follow above requirements for proper drain line setup, air gap and the need for a non-restrictive spring check valve. Allow water to completely drain through line and do not allow drain water to sit in line. Do not restrict drain water flow. Do not cross-connect or tie into to other water lines.

OUTSIDE INSTALLATION

- Install the system where it will not be exposed to direct sunlight or subject to temperatures outside of the limits stated in "Instructions Before Using" on Page 6 in this manual. The system is weather resistant but not weather-proof and it is a requirement to protect the system from outside elements and weather exposure.

■ Follow all instructions found on Page 6, 7 & 11 in this manual and all information, requirements, cautions and hints stated on this page.

■ **Helpful Hint to Protect your System:** If an outside installation is preferable or needed, simply purchase an inexpensive plastic shed at a big box store that can be easily assembled on site and house the system. If applicable, insulation can be applied to reduce heat or cold. If applicable, holes can be made to run pipes, drain line and/or electrical. Any other method you choose is fine as long as the system is protected in a similar manner. Sorry, but nice plants, trees and shrubs are not a protection method.

- Burying the System: If you choose to bury the system for aesthetic reasons, please see the requirements to prevent system damage.

REQUIRED: Place system into a heavy-duty, corrugated, solid wall culvert pipe with a minimum diameter size 2" larger than the diameter of the system that is being installed to prevent ground movement which can cause tank to be crushed.

REQUIRED: Protect top portion and valve of the system that has been placed into the culvert pipe by following all information in this section.

Helpful Hint: A shorter shed, solid covering or a big artificial rock can be used to protect the system from the elements, pets or the kids kicking a soccer ball into it.

INSTALLATION

1. Turn off gas or electric supply to the water heater(s).
2. Turn off the main water supply.
3. Open a hot and cold faucet to drain house water pipes.

NOTE: Keep those hot and cold faucets open until these instructions tell you to close.

4. Move the assembled system into installation position and check that Valve is securely fastened to the Tank.

CAUTION: Factory assembly of Valve to Tank connection is performed according to specifications. However in transportation, delivery and movement to the installation position this connection may have loosened. It is important to make sure this connection is tight and if necessary hand-tighten only in a clockwise direction to ensure this connection.

NOTE: System has a self-leveling base which can compensate for any slight floor pitch. Refer to "Instructions Before Using" on page 6 and "Where To Install The System" on page 7.

5. **Locate water line or pipe to be cut and make sure of direction of water flow.**

CAUTION: Do not cross-connect or plumb backwards. Make sure of the direction of water flow before any connection.

6. **Plumb a Bypass and make Inlet and Outlet Connections to and from the system.**

Bypass must have ball valves on the incoming and outgoing lines and an additional ball valve between the two lines (as illustrated on Pages 9-10) in order to provide a bypass in case of maintenance or any issues. This provides water to the home even if the incoming and outgoing lines to the system are closed and the system is off.

REQUIRED: Use stainless steel corrugated flexible water connectors, PEX or PVC Sch 40 unless restricted by local plumbing code to connect directly into the valve (as illustrated on Pages 9-10).

WARNING: Be sure the incoming raw water supply is connected to the inlet port of the valve.

NOTE: The valve is marked with arrows indicating the proper flow direction.



NOTE:

There should be no extra parts or boxes. Please make sure there are no extra parts or boxes lying around. Once filled with water correcting something can be a problem.

check out pages 9 & 10 for valve and bypass pictures



A flexible capability will assist with the installation where the rough plumbing and finish measurements are slightly off.

WARNING: All threaded connections:
Do not use pipe joint compound or pipe dope.
Use Teflon tape only on all external pipe threads.
Hand tighten only. Do not overtighten.
Make sure any o-rings or gaskets are in place.

CAUTION: Allow for a gentle curve when using flexible connections to avoid a rigid connection.
Support inlet and outlet plumbing in some manner (use pipe hangers) to keep the weight off of the valve fittings.

WARNING: If making any soldered copper connections:
No Heat, Do all sweat soldering before connecting pipes to valve to avoid damage to internal parts.

WARNING: Any pressure on the system exceeding, surging or spiking above 75 psi and any negative pressure due to vacuum break voids the warranty.**

**An operating pressure reducing valve (PRV) may be required on the main water line and prior to the system to regulate pressure. If applicable, a check valve on the main supply before the system or a check valve on the outlet side of the the system (water heater will require expansion tank) to prevent backflow and excessive head pressure may be required. Location of system on the lowest or highest floor or where home is located at the bottom or top of a hill may create head pressure or pressure variances.

FOR ILLUSTRATION PURPOSES ONLY:

This is an example of 3 valve bypass using corrugated flexible stainless to make the final connections with the valve.

Configuration may vary

RECOMMENDATION

LET'S BUILD THE BYPASS AGAINST THE WALL, use less space and make the correct connections:

1. Build your bypass.
2. Secure against the wall.
3. Connect 24" flexible corrugated stainless to your bypass.
4. Create a gentle curve in the flexible piping to avoid rigid connection.
5. Using 2.0" close or shoulder nipples connect your flexible piping to the proper inlet and outlet on the valve

NOTE: Valve has flow in & out direction arrows on the brass inlet & outlet

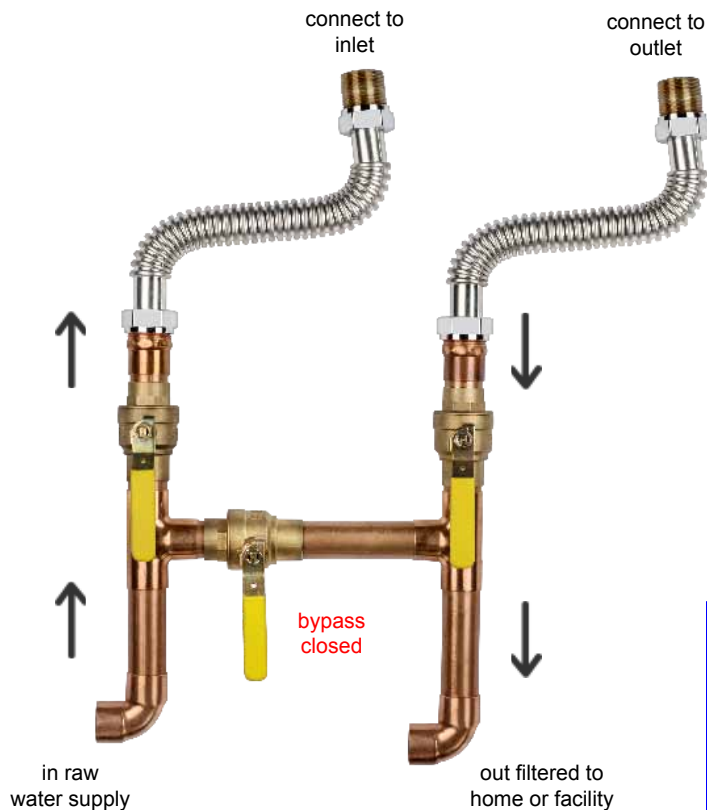

If you build a bypass and secure to the wall, using the required flexible piping will allow you to move the system close to the wall.

This will also allow you to move the flexible piping to connect to the proper inlet and out of the valve and assist with the installation where rough plumbing and finish measurements are slightly off

Plumber installed bypass is required

2.0" brass close or shoulder nipples, 2.0" corrugated flexible stainless, all incoming/outgoing piping and 3 ball valves are not supplied

In the illustration shown the flexible piping would cross in order for the correct connection into the inlet side and the outlet side of this valve.

Your configuration may vary

ILLUSTRATION ABOVE REPRESENTS THE SERVICE POSITION:

In & out valves are open and bypass valve in closed position

CAUTION: All valves should remain closed until startup procedure

A word about the proper installation of a drain line. It appears simple, however if simple mistakes are made it can create many problems associated with this or any system. Please read the instructions below to avoid any issues.

7. Plumb rigid tubing only (PVC recommended if code applicable) directly to the 3/4" FNPT brass drain fitting.

WARNING: Do not use vinyl tubing or any hose type material and clamps for the drain line.

HINT: Install a union on the drain line in order make any service or need to disconnect easier in the future.

8. Connect and route the drain line to a vented sewer drain with a "P" trap or some other drain location. Installation with an air gap is required.

HIGHLY RECOMMENDED: Install a non-restrictive spring check valve in drain line within the first 2' of the drain port to prevent possible back flow. (see below when a non-restrictive spring check valve is required)

REQUIRED: Air gap with proper ventilation is a requirement. Similar to any washing machine, this system must have a minimum of a 1" air gap on the drain to prevent back flow of drain water or gases into the system

REQUIRED: If drain line exceeds 20' in total length, or drain line flows up over 5' above the height of the drain port, or if drain line is being routed outside, expand drain line to 1" ID and install a non-restrictive spring check valve in drain line within the first 2' of the drain port

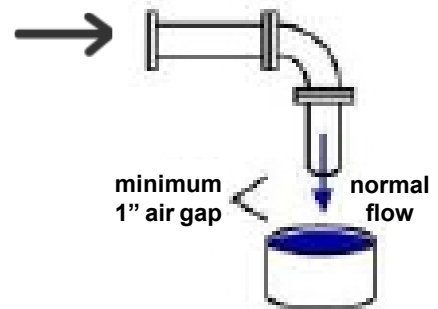

CAUTION: Never install drain line smaller than 3/4" in diameter. Never restrict drain line or drain water flow.

NOTE: Secure (clamp, tie or wire) installed drain line near drain point to prevent movement and avoid any possible water damage.

NOTE: If using a sink, floor drain or any other drain point, an air gap is required and the drain point needs to be capable of draining water away up to 20 gpm for up to 25 minutes every 6 days* to avoid water damage.

* Pre-set from factory is every 6 days which can be adjusted to every 10 days to save water based on usage and water conditions.

CAUTION: Ventilation, Attics and Crawl Spaces: Air gap and proper air flow and ventilation is necessary to prevent any back up or cross contamination into system. Be aware attics and crawl spaces can restrict air flow. Do not enclose or cover up drain point. It would be best if you can see the water flowing from the drain line into the drain point. (see illustration above)

INFORMATION FOR AN OUTSIDE DRAIN LINE:

Do not freeze. Do not block or bury water flow. Do not directly connect to irrigation (bubblers, drip line and/or sprinklers). Create a PVC drain line(s) with holes (distribution header). Drain line and surroundings must be pitched or sloped to allow for proper water flow and drainage where drain water never sits in the line or any landscape or rain water is allowed to create standing water at the drain line. Allow enough space (lawn, planter, water storage) to flow and absorb up to 20 gpm for up to 25 minutes every 6 days to avoid water damage.

REQUIRED FOR AN OUTSIDE INSTALLATION:

A non-restrictive spring check valve in drain line within the first 2' of the drain port to prevent possible back flow.

Backwash is needed for proper filtration and filter life up to 10 years
Drain water is usable for watering and other uses and does not have to be wasted.

INSTALL ELECTRICAL CONNECTION

9. Connect electrical power by plugging the system into a standard grounded and unswitched 110/115/120v electrical outlet.

If outlet is over 16 feet away use 18 gauge extension cord to connect up to 100 feet away. Do not exceed 100 feet. Do not cut or splice original equipment.

NOTE: POWER CONSUMPTION Power consumption is that of a radio alarm clock or a doorbell.

CAUTION: If the home's plumbing system is copper (or any metal) then it may be necessary to install a jumper.

Install a jumper between the incoming and outgoing pipes before and after the flexible stainless connections to maintain the continuity of the systems' ground. Properly ground system to conform with all codes and ordinances.

led screen and what you see when the system is on

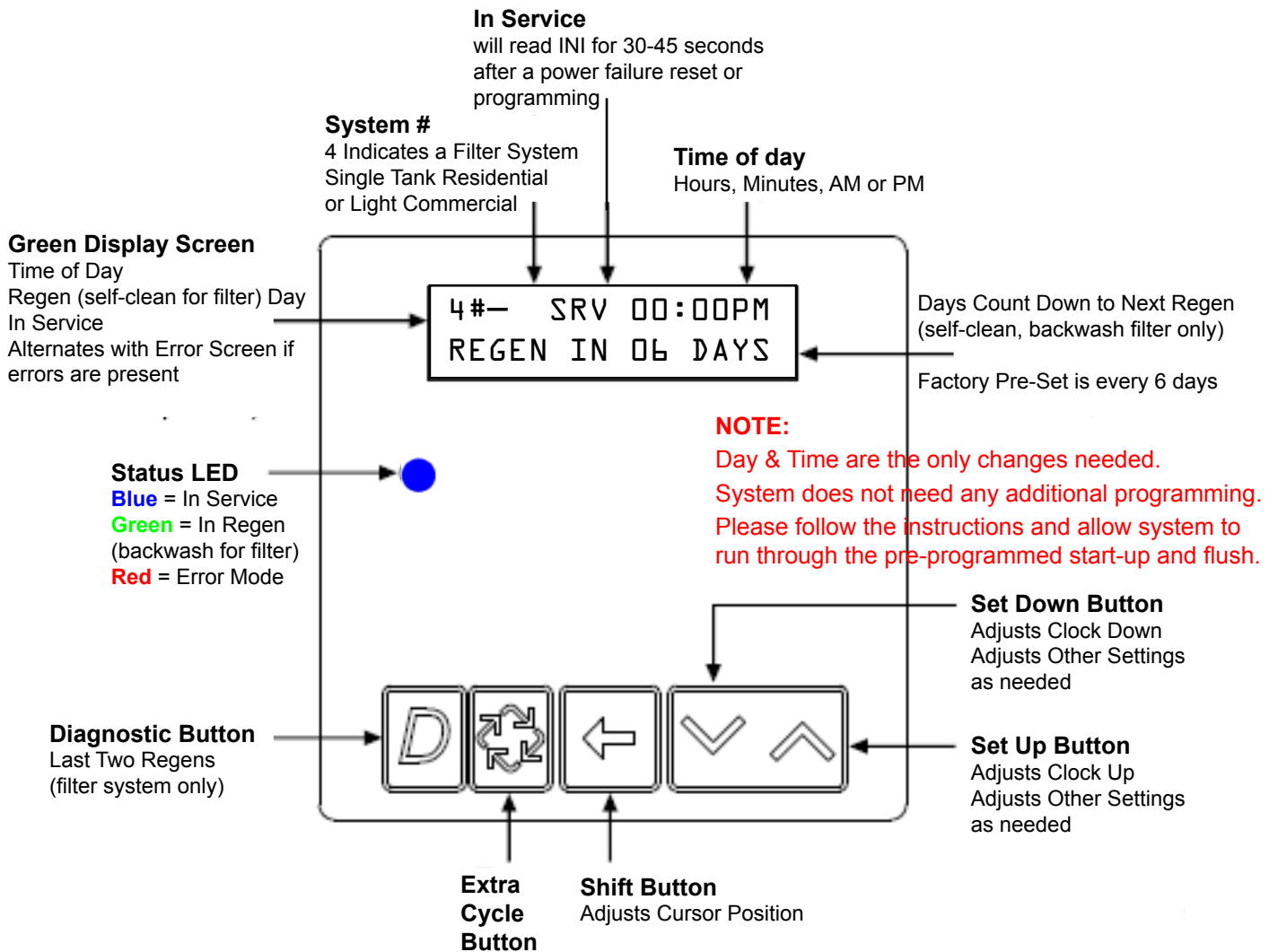

ok, lets, set the clock and start this system up

SET THE TIME OF DAY

10. a. Press and Hold the Up or Down Button for 2 seconds.
Time of Day Screen will appear
 - b. Press the Shift Button to select what digit you want to change
- Note: The hour or minutes you are changing will be underlined.
- c. Set the AM or PM by changing the time up or down until correct.
 - d. Press the Extra Cycle Button to return to the normal display screen

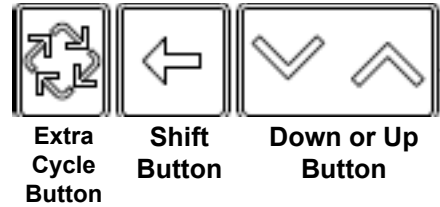
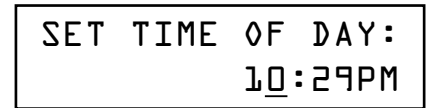

IMPORTANT - CLEAR THE PLUMBING LINES AND CONNECTIONS

11.
 - 1 - Keep the inlet and outlet closed to and from the system
 - 2 - Turn on main water supply
 - 3 - Go to a tub (best) or the nearest faucet, remove aerator and run water through the plumbing system and through your plumbing connections before opening the inlet to the system or beginning the start up procedure
 - 4 - Now that lines have been cleared, shut off water to the tub or faucet and follow start up procedures

WARNING:

Debris may be present in the lines from closing and opening the main supply or from plumbing connections made prior the system. We want to prevent any debris from entering the valve and causing damage to the piston, spacers and seals.**

**Debris in the valve can cause a leak to the drain (similar to a leak in a faucet or shower valve where the water does not shut off completely) which can require additional service or the purchase of new parts.

start up procedure - fill the tank and start to flush the system

FILL THE TANK - SLOWLY

12. Partially open the inlet as shown

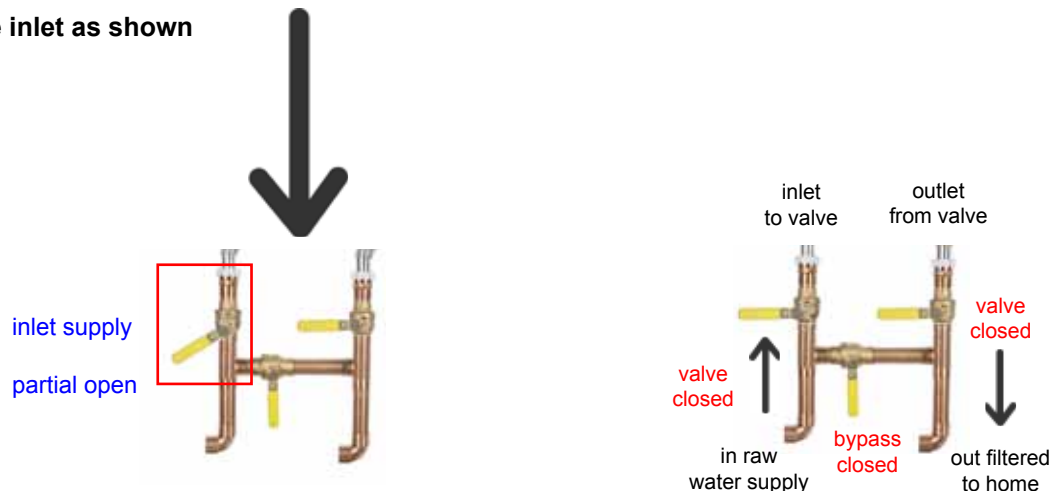

CAUTION:

Open slowly to prevent rapid flow and high initial pressure into the system

go to step 13 on next page and begin to flush the system

START UP TO FLUSH THE SYSTEM

13. **Press and Hold the Extra Cycle button**

Release when you see the Screen change to Cycle 1

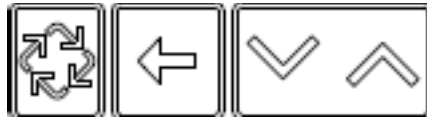

Extra Cycle Button



NOTE:

Day & Time are the only changes needed.

System does not need any additional programming.

Please follow the instructions and allow system to run through the pre-programmed start-up and flush.

14. **Once system begins to backwash Slowly open the inlet only and keep outlet closed**

CAUTION: Open inlet slowly and keep outlet closed.

NOTE: This cycle allows air to be purged from system while initially filling the tank. Little or no water will be seen coming out of the drain until tank has been filled completely.

NOTE: The remainder of the cycles will flush the system.

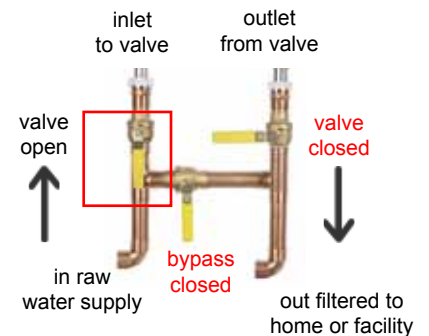

Keep the inlet open and make sure the outlet is still closed

These are the system start up and self-cleaning cycles and the duration:

Cycle 1. Backwash: See Steps 12 & 13 above. This cycle will count down and last 10 minutes.

After 10 minutes, valve will adjust and screen will change.

Cycle 2. Slow Rinse: This cycle will count down and last 5 minutes.

After 5 minutes, valve will adjust and screen will change.

Cycle 3. Rapid Rinse: This cycle will count down and last 10 minutes.

After 10 minutes, valve will adjust and screen will change.

Valve will tell you that it is heading home.

Valve returns to the home screen. In Service, Pre-set next backwash in 6 days and correct time of day

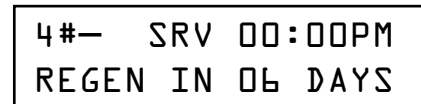
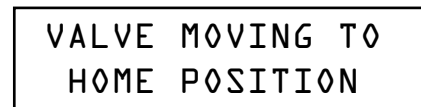
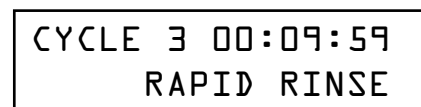
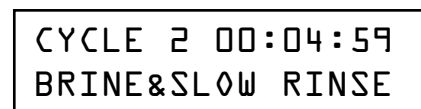

check the drain water and put the system in service

15. Observe the drain water during Cycle 3. Rapid Rinse

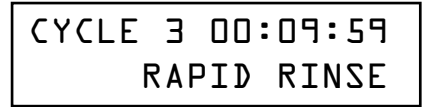

If the water is running clear - proceed to Step #16.

If the water remains grey - go back to Step #13 on Page 14.

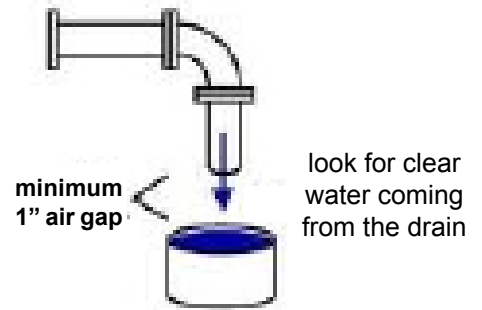

CAUTION: If the drain water remains grey, Press the Extra Cycle Button and repeat the flushing sequence until the water from the drain line runs clear.



16. Open outlet and put the system in final service position (see illustration below)

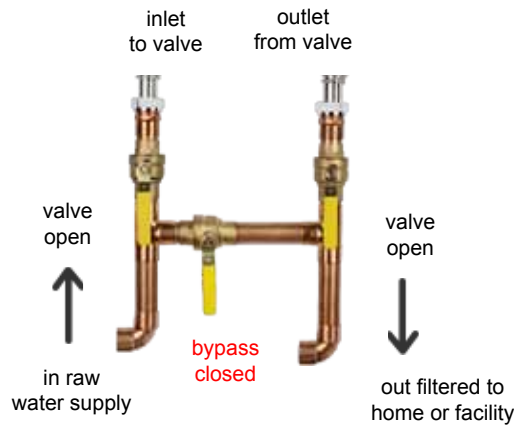

This is the Service Position

inlet open from water supply to system
outlet open from system to home
bypass between the inlet and outlet is closed

STOP - IF YOU DID NOT FOLLOW THE INSTRUCTIONS:

Do not put system into service until proper installation, setup, clearing the plumbing lines and startup procedures have been followed.

17. **System is ready for use.**

Turn on gas or electric supply to the water heater(s).

To ready facility for filtered water, please flush all the water throughout the home.

- open as many hot and cold faucets through out the home as possible,
- remove the aerators or any restriction at the end of the faucets,
- run tubs (if applicable),
- flush toilets,
- dispose of any ice previously made
- run water throughout facility home for 5 minutes.



Create Happy Customers

18. **Final Checklist**

- check all connections,
- pressure not to exceed 75 psi,
- make sure system was not installed backwards
- using the proper flexible piping
- make sure drain is correctly installed and drain water was running clear.



Avoid Problems and Callbacks

NOTE: CLOUDY WATER

If water appears cloudy, allow to run for several more minutes until all air is expelled or until clear.

NOTE: PRE-EXISTING CONDITIONS, OLDER HOMES OR FACILITIES, HEAVY SEDIMENT

If location is a year or more old, it is highly recommended that all water heaters or tankless on-demand heaters be flushed and that all dishwashers, washers and any other water appliances be cleaned of any existing residue.

Please review Page 6 “Instructions Before Using” for existing plumbing and pre-existing conditions that will effect the performance of this system.

WARNING:



Failure to follow these procedures can result in debris in the system, the system’s valve, the home or facility, and/or filtration media being expelled. Expelled media will cause immediate short and long term issues with the system’s valve, and will enter pipes and the fixtures or appliances within the home or facility.

parts breakdown - ews/cwl-1665-2 & ews/cwl-cc-2472-2 filtration systems

(for illustration only)



Brass Drain Adaptor (DLFC)
3/4" FTNP
(Pictured installed on the valve outlet side)
Drain Flow Rates:
all 1665 & 2472 systems: 20 gpm

Below represents a fully assembled 1665 system from a front view.

Sizes will vary based on model



Front View; Fully Ported 2.0" Valve
4" valve base

- Riser Distribution ORing
- Valve Tank ORing
- Upper Valve Screen

Electric:
24 volt plug & play transformer with 16' cord
Note: Valve consumes the power equal to a doorbell

Tank:
16" x 65" (pictured)
Food & beverage grade, non-corrosive, one-piece, blow-molded polyethylene interior with structured fiberglass outer laminate.
4" opening

Filtration:
EWS proprietary, high grade, 1200 iodine rated, granular activated carbon (GAC). No binders, fillers or metal resins

1665-2 systems: 4.0 cu.ft.



EWS proprietary, chloramine reduction media (CRM) additional processed for advanced filtration due to chloramine (chlorine & ammonia)

2472-2 systems 10.0 cu.ft.

Note - Freeboard:
Top 1/3 of tank is empty for proper backwash and lift of filtration media for the automatic self cleaning of the system

self leveling base



Underbed:
Specific pea gravel materials for proper water and backwash flow and distribution
50 lbs. for all systems



Tank Wrap:
eco-cover for tank with contact information and information important for the proper application of the system.



Riser: (CWL-SYSTEMS)
Food & beverage rated pvc water distribution riser with lower screen

ICN Riser & Manifold: (EWS-1665-2 - pictured)
Food & beverage rated pvc water distribution riser with lower screen and ICN Manifold for Conditioning.
EWS-1665-2 system - 3 ICN's
EWS-CC-2472-2 system - 6 ICN's

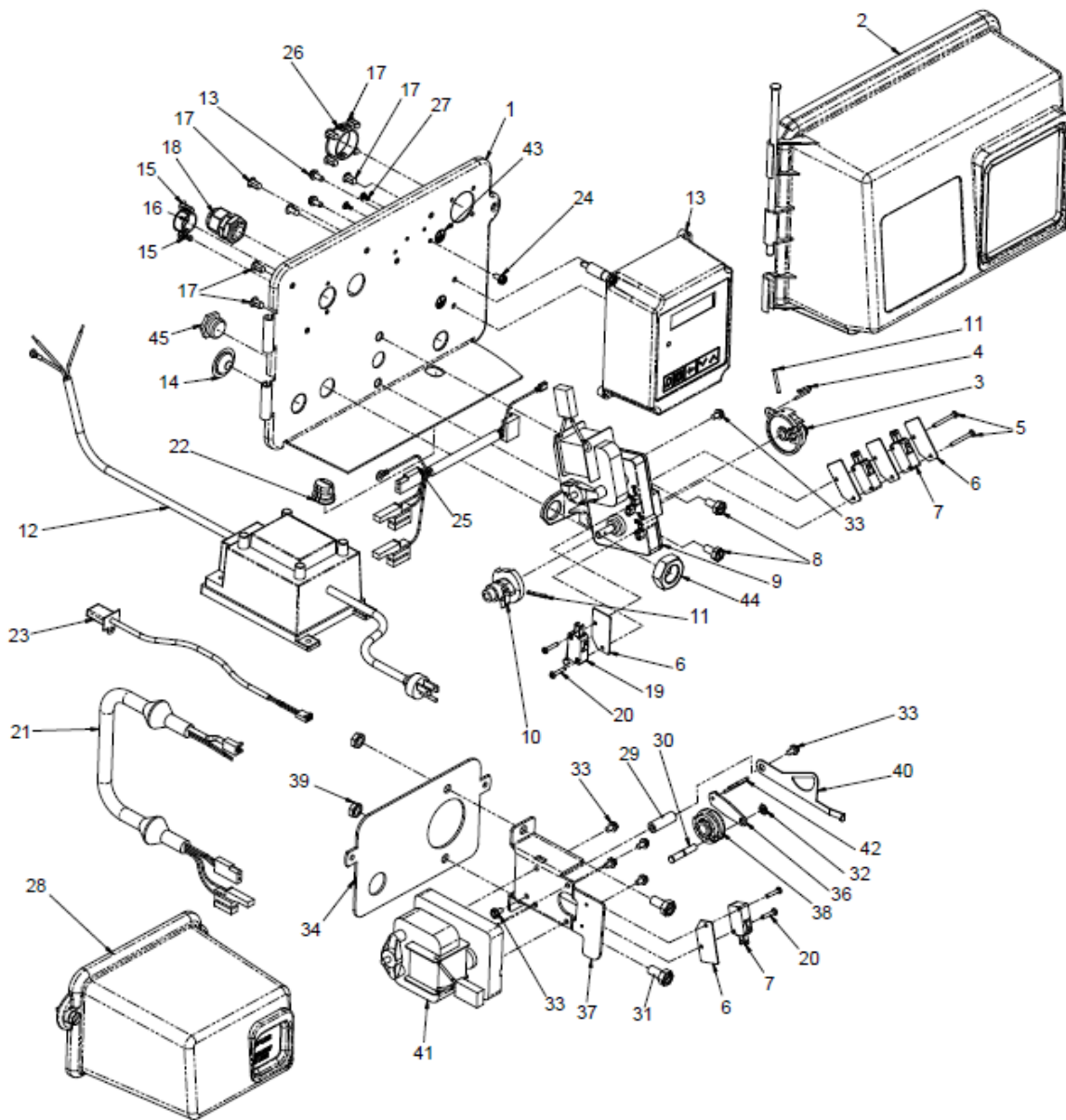

Item No.	Quantity	Description
1	1	Backplate, Hinged
2	1	Cover Assy, Environmental, Black
3	1	Drive Cam Assy, STF, Black
4	1	Pin, Link
5	2	Screw, Pan Hd Mach, 4-40 x 1
6	5	Insulator, Limit Switch
7	3	Switch, Micro
8	2	Screw, Slot Hex, 1/4 - 20 x 1/2
9	1	Motor, Drive, 24V/50-60 Hz
10	1	Cam, Shut-Off Valve
11	2	Pin, Roll, 3/32 x 7/8
12	1	Transformer, US, 120V/24V, 108VA
		Transformer, Euro, 230V/24V
		Transformer, Aust, 230V/24V
13	1	Timer Assy, XT, Right Hand
14	1	Plug, .750 Dia Hole, Flush
15	2	Plug, .140 Dia, White
16	1	Plug, Hole, Heyco #2693
17	9	Plug, .190 Dia, White
18	1	Fitting Assy, Liquid Tight, Blk
19	1	Switch, Micro
20	4	Screw, Rd Hd, 4-40 x 5/8 Type 1
21	1	Wire Harness, Lower Drive
22	1	Strain Relief, Flat Cord
23	1	Meter, Cable Assy, 3200NT
		Meter Cable Assy, NT, 35" w/Connector
		Meter Cable Assy, NT, 99.5"
		Meter Cable Assy, NT, 303.5"
24	1	Screw, Hex Wsh Mach, 8-32 x 5/16
25	1	Wire Harness, Upper Drive
26	1	Plug, 1.20 Hole
27	2	Plug, Hole, .125 Dia, White
28	1	Cover Assy, 2900, Lower, Black
29	1	Spacer, Indicator
30	1	Bearing, Connector Rod
31	2	Screw, Hex Hd, 5/16 - 18 x 5/8
32	1	Ring, Retaining
33	7	Screw, Hex Wsh, 8-32 x 17/64
34	1	Backplate, Lower
35	1	Pin, Roll, 2900/3900
36	1	Link, Piston Rod
37	1	Bracket, Motor, 2900
38	1	Cam, Drive, 2900
39	2	Nut, Hex, Jam, 5/16 - 18, 18-8 SS
40	1	Indicator, Service/Standby
41	1	Motor, Drive, 24V, 50/60 Hz, SP
42	1	Pin, Spring, Connecting Rod
43	1	Label, 3200NT, Ground
44	1	Nut, Jam, 3/4 - 16
45	1	Fitting, Brine Valve

Notification:

This warranty is referenced by EWS, Inc. in all literature, addressed in General Terms and Standard Conditions of Sale, and is published in its entirety in all EWS, Inc. product manuals, websites, and in all service guides supplied with all product.

Limited Warranty:

EWS, Inc., a Nevada corporation, hereby warrants all products to the original consumer purchaser to be free from defects in material and workmanship as stated in the following paragraphs:

- All residential point of use: countertop filtration, in-line filtration, undercounter drinking water filtration, shower filtration, residential reverse osmosis, and canister and filter cartridge point of entry pre-sediment and/or filtration units or systems for one year from date of purchase.
- All residential point of entry: pH decreasing and softener (resin and ion-exchange) systems, Environmental (EWS) Water Systems, Iron Removal units, CWL whole-home (filtration media) systems, pH increasing reagent (sacrificial media) units for 10 years on the tank and riser, 10 years on the ICN conditioner(s) (if applicable) and 5 years on the valve body and electronics from date of purchase.
- All commercial systems: Dependent on specification and application, please consult with EWS, Inc. upon specification.
- All filtration medias, resins, cartridges, uv lamps, and/or membranes are not covered by any warranty. Filter media, resin, cartridge, uv lamp, and/or membrane replacement or maintenance schedule will vary and must be replaced, as necessary, as determined by usage and local water conditions.
- Any wear and tear parts or any parts damaged in shipping, installation or application are not covered under warranty.

Product performance may vary based on local water conditions, proper product specification and application, proper plumbing application, setup, installation, startup, maintenance and/or usage. To ensure proper operation, follow all setup, installation, start-up and maintenance procedures as detailed in all service guides.

Not intended for use where water is microbiologically unsafe or with water of unknown quality without adequate disinfection before or after unit(s). The contaminants or other substances removed or reduced by these and any other water filtration or treatment devices are not necessarily in your water. To confirm the presence of any primary and secondary contaminants, have your water supply completely analyzed by an independent and approved facility or if applicable, contact your local water utility for information.

Aesthetic, non-health related, or constituents without set federal standards may be part of water testing but are insufficient to determine proper application of any water filtration or treatment device.

EWS, Inc. will replace, free of charge, during the warranty period, any part which proves defective in material and/or workmanship under proper product and plumbing specification and application, normal and proper installation, use, service and proper care as published in detail in all service guides included with product. Wear and tear parts such as pistons, spacers & seals are not covered under warranty. Labor charges are excluded from any warranty service or repair and are not the responsibility of EWS, Inc. Shipping charges may apply to delivered replacement parts or materials. Charges may also apply for the cost of any replacement media, resin, cartridges, uv lamp and/or membrane from any warranty service or repair. Information can be obtained at any time through a local dealer, distributor, representative or direct from EWS, Inc. and/or on-line at; www.ewswater.com. Replacement parts can be obtained from your local dealer, distributor, online or contractor.

This warranty is the exclusive warranty granted by EWS, Inc. and is in lieu of all other warranties of merchantability and fitness for a particular purpose and is further limited to defective parts replacement only. Labor charges and/or damage incurred in setup, installation, and startup, or repair, or replacement, as well as, incidental and consequential damages connected therewith, are excluded, and are not the responsibility of, and will not be paid by EWS, Inc.

This warranty is void for any damages due to improper product and/or plumbing specification and/or application, misuse, abuse, neglect, accident, acts of nature, action of any military or civil authorities, improper handling and transportation, or improper setup, installation, and/or startup, or any violation of instructions furnished by EWS, Inc., or any replacement parts other than genuine parts or replacements supplied by EWS, Inc.

This warranty is not a warranty of merchantability, fitness, taste, aesthetics, and/or performance that may be subject to improper product and/or plumbing specification and/or application, misuse, abuse, neglect, accident, acts of nature, action of any military or civil authorities, improper handling and transportation, or improper setup, installation, and/or startup, or any violation of instructions furnished by EWS, Inc.

This warranty is not a warranty of merchantability, fitness, taste, aesthetics, and/or performance that may be personal and of subjective opinion and that does not relate to the performance of any system.

Warranty Information and the Purchaser's Responsibility

Keep a record of the purchase receipt and/or installation receipt. Purchaser is required fill out warranty registration form(s) on applicable product(s) and register all product by either online @ www.ewswater.com, telephone, postal delivery, fax, e-mail (either register@ewswater.com or information provided to customerservice@ewswater.com). **Failure to do so voids the warranty unless restricted by state regulations.**

Privacy: EWS, Inc. does not sell, show or make available any information on any consumer in our database. This database is to ensure, if needed, proper warranty service, and good customer service for years to come. Please see our privacy policy published in our website at www.ewswater.com.

Know Your Water:

- If on a municipal system, large or small, it is your right as a consumer to have access to the most recent test results and to expect adherence to federal guidelines, as well as any state or local requirements. Any problems should be reported to the appropriate agencies. Please acquire those municipal test results to become an informed consumer.

- If on an individual well, have your water completely and independently tested. Local code may require a simple test for coliform bacteria to approve a well, however you may be unaware of potential problems for you and/or your home. A local water salesman is looking to close a sale and is going to test for hardness minerals and a few simple and obvious issues, which may or may not be contamination problems. Their solution is almost always the same and yet may provide no resolution to any true problems. Obtain our "Guide for the Private Well Owner" on our website; www.ewswater.com. Review our section on well water testing and applications in our complete catalog with your local distributor, dealer, or our representative or visit our website.

• WARNING:

Some restrictions apply to the use of softeners. Contact your local municipal water district or Gov't Agency. Brine discharge is already restricted on, or may be a problem for, septic applications and waste water treatment facilities. Since some states have already restricted softeners to metered valves to prevent excessive brine discharge, EWS, Inc. only provides metered valving in its line of softeners.

Restrictions or an outright ban may also apply to hot-side only, salt-exchange tanks or services. Local water dealers and other organizations do not inform consumers of these issues and believe these rules are unenforceable. The consumer is ultimately responsible.

Softeners may also provide warranty issues with pools and spas, certain other products and finishes. Softened water should not be used for drinking, cooking, pets or plants and is usually bypassed or "looped away" from the cold side of the kitchen sink. Reverse osmosis, which also has its drawbacks and issues with other products and materials, may be used to remove the salt from the water that the softener put in at the kitchen sink, yet may be misapplied for the actual local water conditions.

Any problems of water quality, or the fitness of any EWS, Inc. product that is associated with any mechanical, construction, application, installation, and/or environmental issue(s) (ie: flow rates, line pressure, piping materials, broken supply lines, changing water conditions; well or municipal water quality, et. al.), known or unknown, of the home or facility will not be considered by EWS, Inc. until such issue(s) have been resolved.

Responsibility for the proper product and/or plumbing specification, application and/or installation of any device manufactured by EWS, Inc. lies with the consumer, their builder contractor, plumbing sub-contractor and any other installer of choice. Items do not specify and/or install themselves. EWS, Inc. has provided many sources to acquire information on the proper application of systems and their installation prior to any purchase. EWS, Inc. manufactures a complete product line of point of use water filtration systems and point of entry filtration, softening and/or conditioning systems and/or appliances.

EWS, Inc. and the distributors of EWS, Inc. will stand behind the warranties of materials and workmanship. However, EWS, Inc. and the distributors of EWS, Inc. and the Environmental Water Systems Product Line do not bear any responsibility for improper applications of product and/or improper installation. It is for this reason that EWS, Inc. provides complete information on all product for your understanding, specification, application and selection, and proper plumbing application and installation.

To obtain warranty service support, contact your local dealer or contractor from whom you obtained the product or contact EWS, Inc., Customer Service, via phone, fax, or email.

The EWS, Inc./Environmental Water System Product available through:



Authorized Kitchen & Bath Showrooms, Appliance Showrooms, Building & Plumbing Wholesale Supply Locations and their building, plumbing, HVAC and service contractors, and Authorized Online Distributors.

EWS is a Proud Contributor and Sponsor of Organizations Dedicated to Improving Health, Well-Being and the Environment

- Heart • Lung & Respiratory • Allergy & Asthma • Dermatology & Skin • Digestive: Crohn's & Colitis •
- Oceans • Inland Water Ways • Wetlands • Forestry • Soil • Air •



ALL FILTRATION PRODUCT PROUDLY MADE & ASSEMBLED IN THE USA



ENVIRONMENTAL WATER SYSTEMS[®]
Quality Water Filtration Crafted in the USA Since 1987.

WWW.EWSWATER.COM

Customer Service Monday–Friday 8:00am–4:30pm PST
Office: 702-256-8182 Fax: 702-256-3744
customerservice@ewswater.com

EWS, Inc. Corporate Offices
5542 S. Ft. Apache Rd, Suite 110
Las Vegas, NV 89148