

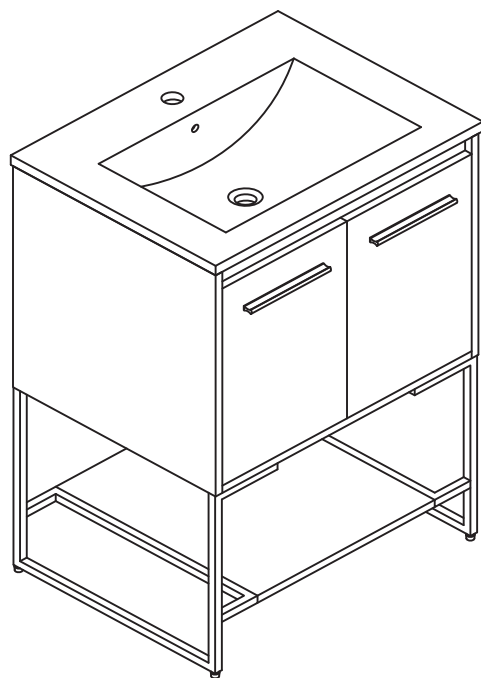

ASSEMBLY INSTRUCTIONS

VF42530MBL / VF42530MGN / VF42530MWT
 VF42530MTK / VF42530MMP / VF42530MWH
 VF42530MCG



Step 1

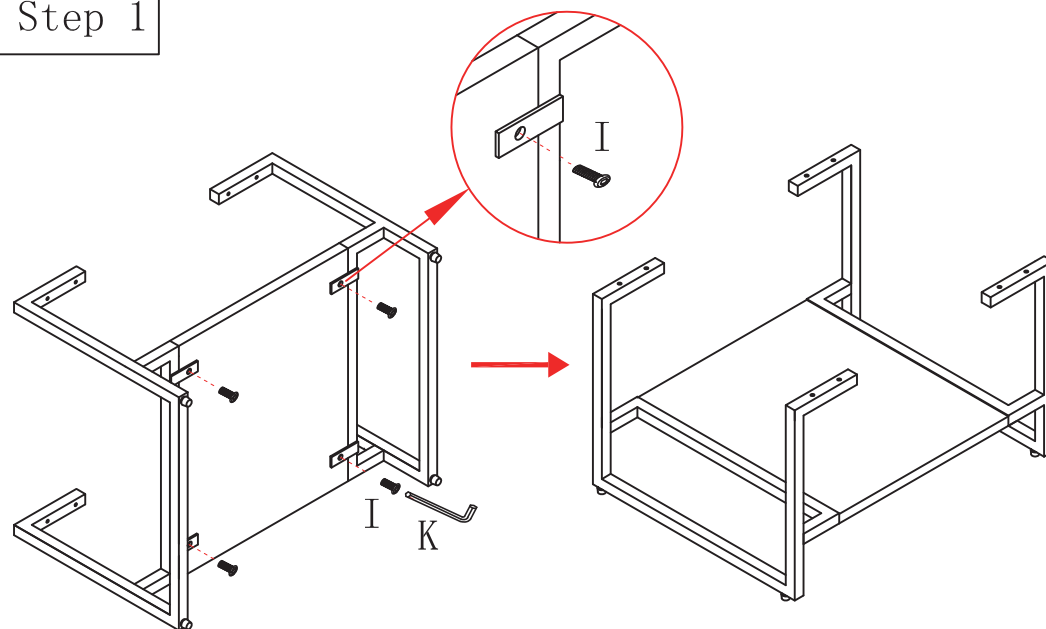

Step 2

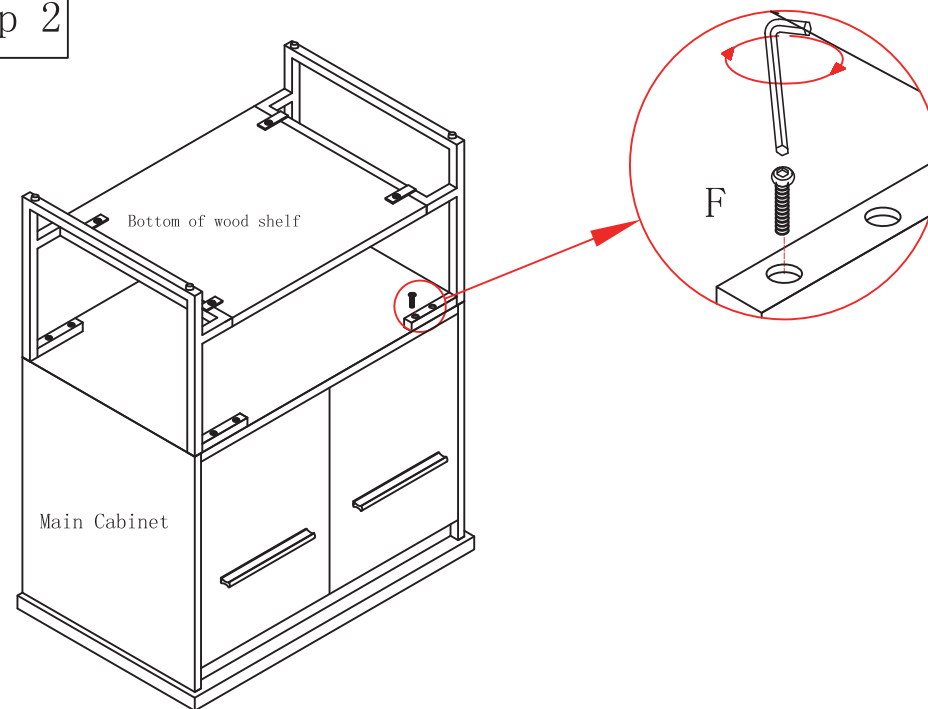

Hardware

NO.	Parts	QTY	NO.	Parts	QTY
A	(M6*1.18")	4	E	(M6*2.36")	2
B		2	F	(M6*1.02")	8
C	(T4*1.38")	4	H	(M8*1.57")	2
D	(T4*0.55")	2	I	(M6*0.55")	4
			K		1

Tools

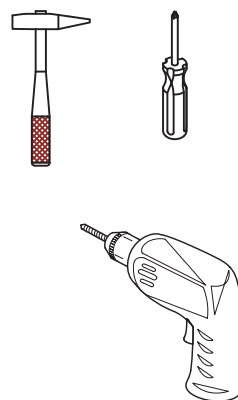

The main cabinet upside down.

Step 3

Wall

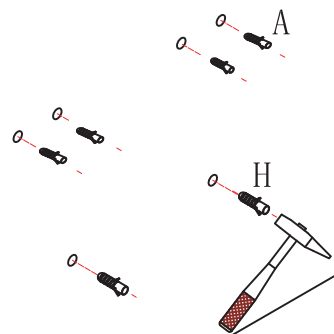

Step 4

Wall

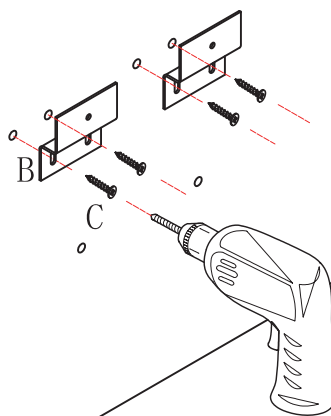

Step 6

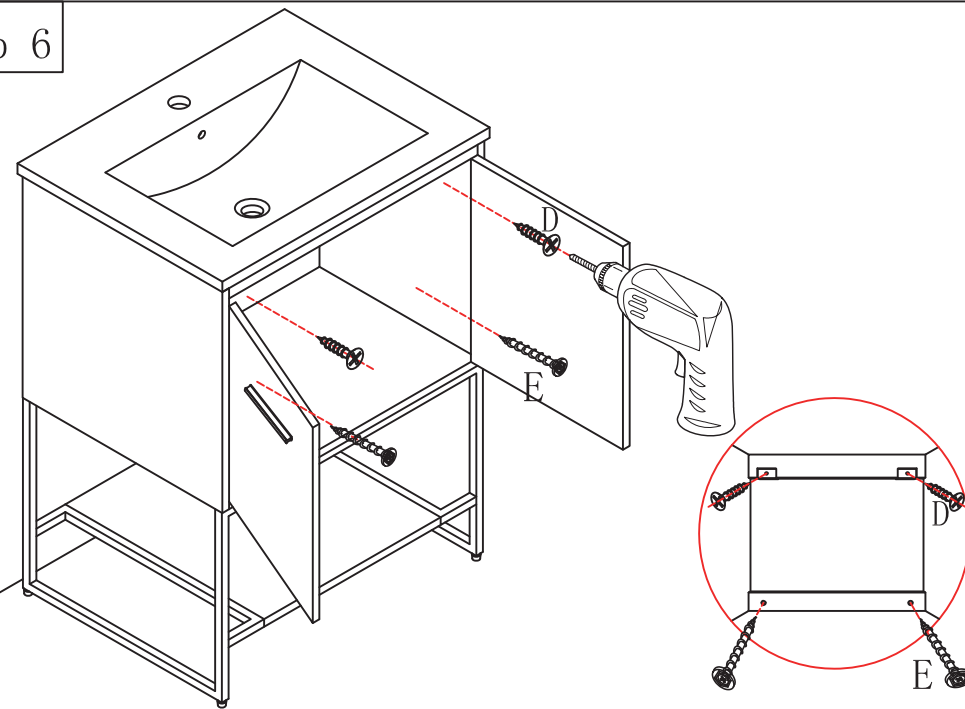

Step 5

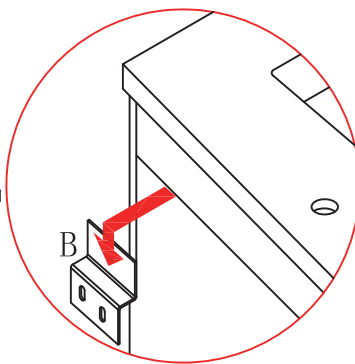
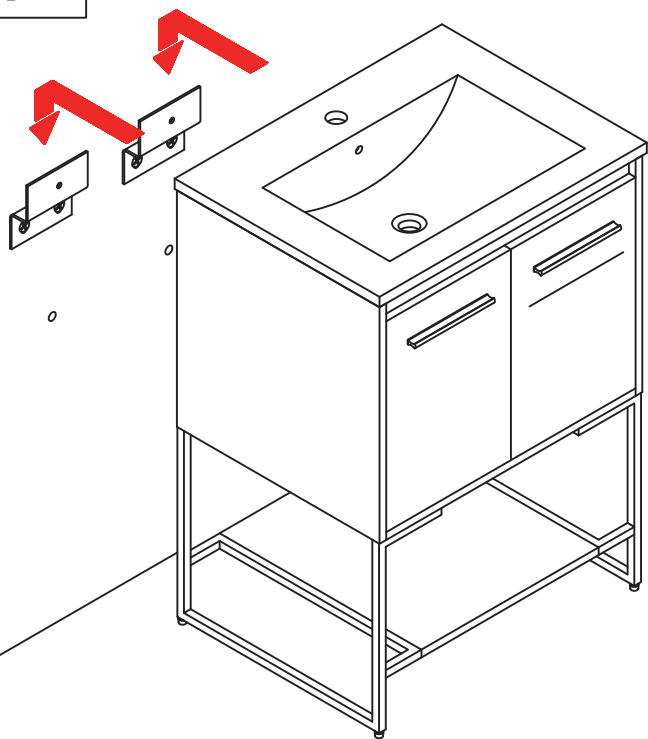

Finished

33.85"

