

ELEGANT

FURNITURE & LIGHTING™

Installation manual for:

V1800G72

Dimensions:D72” H96” L66

Collection:Primo

Bulb Type:E12 bulb not included

Lamp Frame Weight(lbs):167.2

Total Weight(lbs):538



Thank you for choosing our product(s).

Our Company is actively involved in every step of the production.

Our product(s) are designed to be utilized for every application that graces your home or business.

We pride ourselves in providing the most prompt and courtesy service to all of the valued customers.

Please find the enclosed detailed instruction and read carefully for proper installation.

If you have any questions, please contact the retailer where the purchased was made.



SAFETY

Warning: MAKE SURE THE ELECTRICITY TO THE WIRES YOU ARE WORKING ON IS SHUT OFF. BY EITHER REMOVING THE FUSE OR TURNING OFF THE CIRCUIT BREAKER.

CAUTION

- Before assembling the lighting fixture, please read all instructions carefully.
- All frame & crystal components are fragile, please handle with care.
- Required supply circuit : 110 - 130V/60Hz
- Labeled wires are "L" for live wire, "N" for neutral wire, "E" for ground wire.
- Never install fixture on damp ceiling, the room should be dry and well ventilated
- All electrical components must be installed by a licensed electrician and in accordance with the National Electrical Code and the appropriate local electrical codes.

Unpack the Package

Please open the box carefully and check all the items are inside the box. If you have any installation, assembling and missing parts questions, where you purchase from and any other relevant information ready, our customer service team will provide comprehensive and worry free service to our valued customers.

Frame Parts List

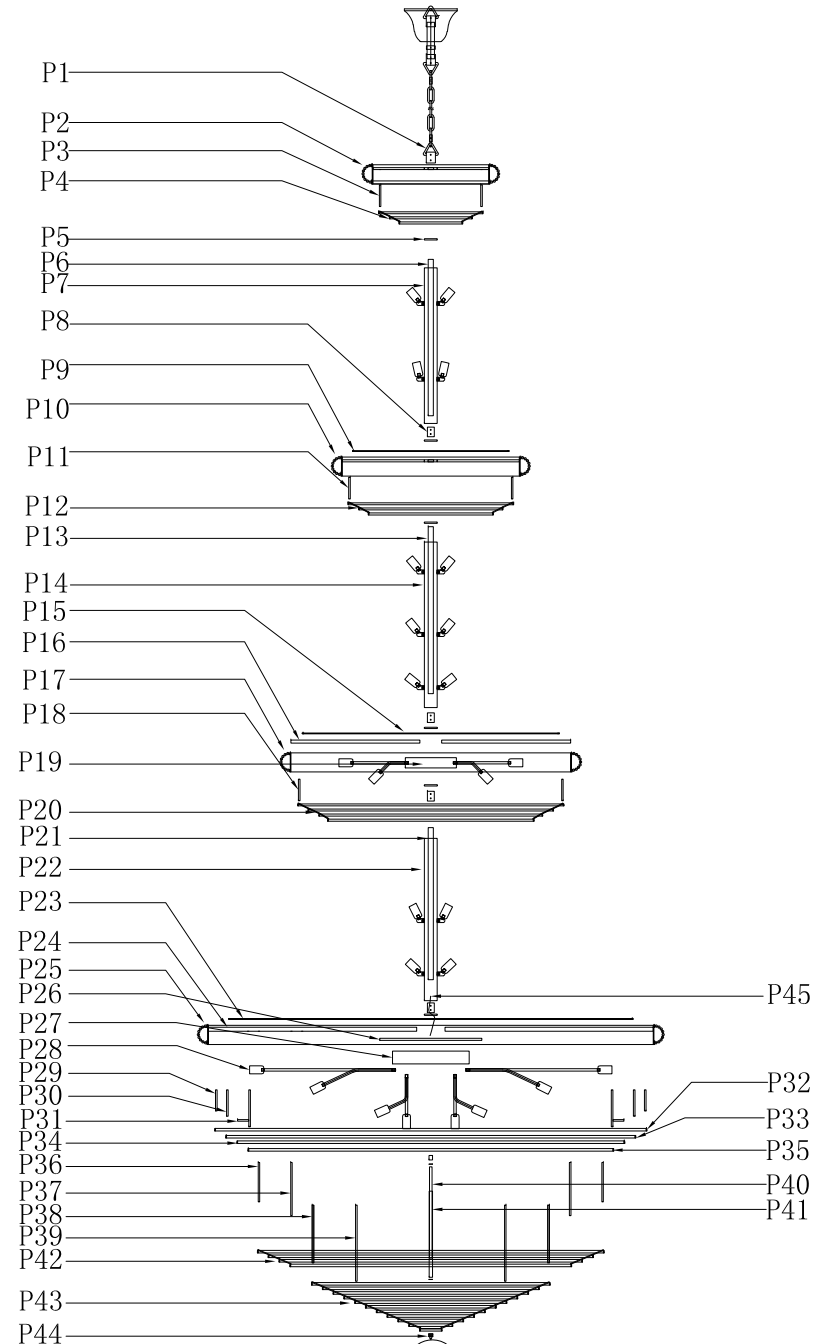











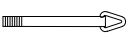

V1800G72 D72" H96" L66

Step 1

Please use the parts list to ensure you are not missing any parts



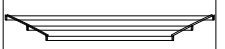





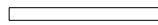

V1800G72

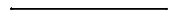
PARTS LIST

part	picture	Description	Parts Number	Qty	Check list
ZA		Crossbar	CP1020R90	1	
ZA		Crossbar			
ZB		9"Canopy			
ZC		Canopy ring			
ZE		ROD1025			
ZE		L59"CHAIN10T Plain Design	CHAIN10P	1	
ZE		Power Cord 12' SPT-2-16# Clear/Gold		1	
P1		Loop		1	
P2		Lamp body (1)		1	
P3		3"Iron bracket		4	
P4		16.6"Frame		1	
P5		Cover		8	

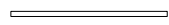
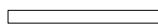









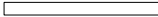

03

V1800G72 D72" H96" L66















part	picture	Description	Parts Number	Qty	Check list
P6		24.2"Both end Threaded pipe		1	
P7		24"Metal tube		1	
P8		Coupling 4PCS Attach to the frame		5	
P9		24"Metal ring		1	
P10		Lamp body (2)		1	
P11		3"Iron bracket		6	
P12		26.6"Frame		1	
P13		25.8"Both end Threaded pipe		1	
P14		25.6"Metal tube		1	
P15		39.3"Metal ring		1	
P16		19.9"Iron bracket		8	
P17		Lamp body (3)		1	
P18		3"Iron bracket		8	





04

V1800G72 D72" H96" L66

part	picture	Description	Parts Number	Qty	Check list
P19		7.8"Metal wire box		1	
P20		41"Frame		1	
P21		25"Both end Threaded pipe		1	
P22		25.4"Metal tube		1	
P23		59.7"Metal ring		1	
P24		31.8"Iron bracket		12	
P25		Lamp body(4)		1	
P26		15.7"Metal plate		1	
P27		11.8"Metal plate		1	
P28		E12 Lampholder		66	
P29		3"Iron bracket		12	
P30		4"Iron bracket		12	
P31		"L"Iron bracket		12	

V1800G72 D72" H96" L66

part	picture	Description	Parts Number	Qty	Check list
P32		66.3"Metal ring		1	
P33		63"Metal ring		1	
P34		59.6"Metal ring		1	
P35		56.3"Metal ring		1	
P36		6.3"Iron bracket		6	
P37		8.6"Iron bracket		6	
P38		9.4"Iron bracket		6	
P39		12.6"Iron bracket		6	
P40		15.5"Both end Threaded pipe		1	
P41		15.4"Metal tube		1	
P42		53"Frame		1	
P43		Bottom Frame		1	
P44		Finial		1	
P45		Steel wire		1	

part	picture	Description	Parts Number	Qty	Check list
A		1050-14#*3	/	794	
B		701-40#		1609	
C		1050-14#*31		54	
D		1050-14#*33		108	
E		1050-14#*37		168	

part	picture	Description	Parts Number	Qty	Check list

step 2 Canopy Installation Instruction

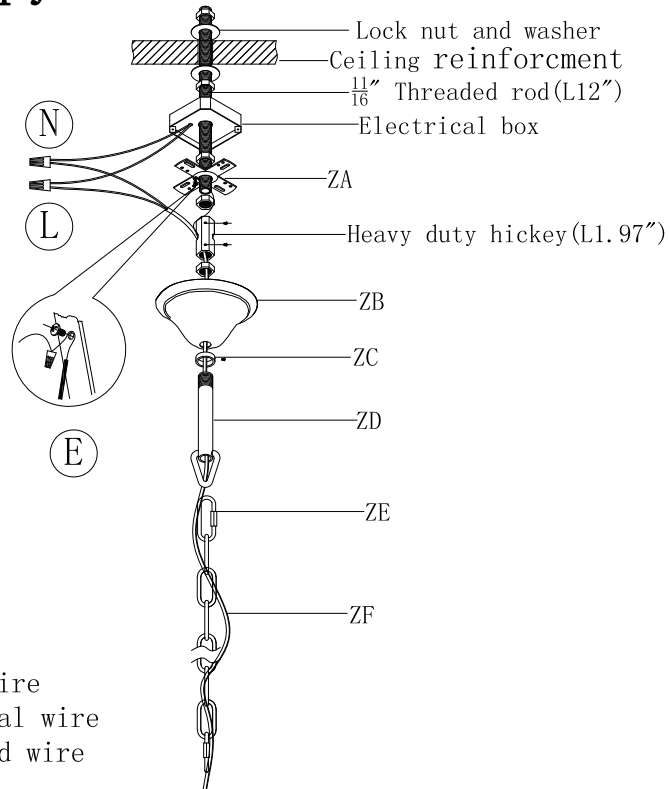

"L" = Hot wire
 "N" = Neutral wire
 "E" = Ground wire

IMPORTANT: Test sockets with bulb before dressing the fixture.

1. Drill a $\phi 0.7$ " hole in the ceiling reinforcement to allow a $\frac{1}{16}$ " threaded rod to pass through.
2. Attach the electrical box to the ceiling reinforcement and pass the $\frac{1}{16}$ " threaded rod through the box and secure it to the heavy duty hickey.
3. Pass the fixture wires and ground wire through the loop, canopy ring, center hole of canopy and the heavy duty hickey.
4. Pull ceiling wires down through the fixture box and make connection.
5. Screw loop only onto threaded pipe.
6. Hang the fixture on chain.
7. Secure the canopy with canopy ring.

09

Canopy Installation Instruction

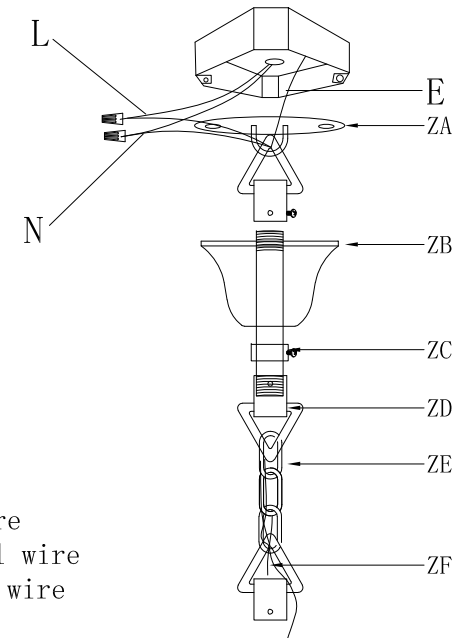

"L" = Hot wire
 "N" = Neutral wire
 "E" = Ground wire

Please read all instructions carefully. Before you proceed to install, make sure that the power supply is turned off and off until installation is complete. Please note that each part has been assigned a letter. Please proceed in alphabetical order.

1. Fix the crossbar (ZA) to the ceiling with the two crossbar screws.
2. Hang the Canopy ring (ZC) back up over the canopy (ZB), through metal rod (ZD) together.
3. Hang the electric main and ground wire through the chain (ZE), the Metal rod (ZD), the Loop and the crossbar (ZA) until the end of the electric main reaches the junction box where you can make the appropriate connections.
4. Be sure when connecting the wire use electrician approved junction caps.
5. Stow the excess wire in the junction box (ZA).
6. Raise the canopy (ZB).
7. Canopy ring (ZC), attach canopy (ZB) to ceiling, slide metal ring (ZC) over canopy lock (ZD) and hold the canopy (ZB).

10

Frame Assembly Diagram

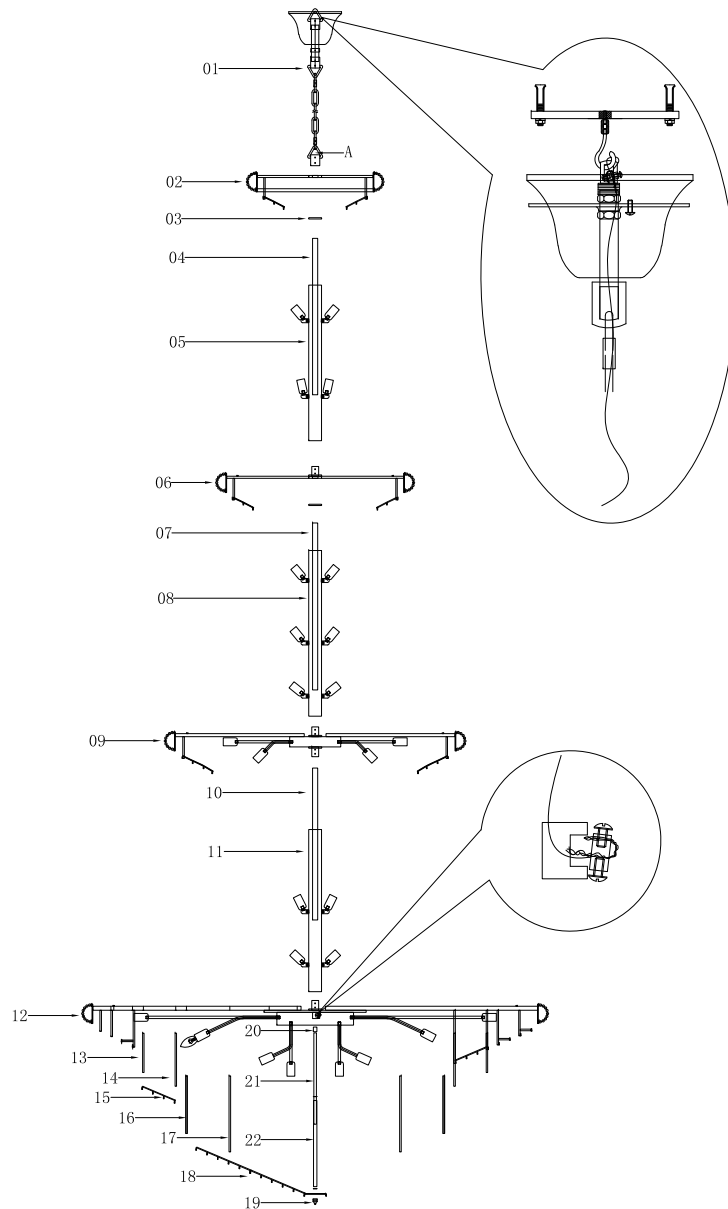

11

Step 3

Frame Assembly Instructions

Installation:

Please read all instructions carefully.

Before you proceed to install, make sure

that the power supply is turned off and remains off until installation is complete.

Please note that each part has been assigned a number.

Please proceed in a numerical order.

1. Hang the chain (01) on the ceiling.
2. Pass the (12) main wire through the (10), through the (11), screw it with (09), connect (09) of the inside positive and negative charges of the wire, screw them with crossbar cap.
3. Pass the (09) main wire through the (07) (08), screw it with (06).
4. Pass the Steel wire through the Cylinder Screw Connector, (12) (11) (10) (09) (08) (07) (06) (05) (04) (03) (02) (01), screw it on the **Crossbar**.
5. Screw iron bracket 6.3" (13), 8.6" (14) on the lamp body (12) dressing holes with M3*8 screws.
6. Screw the bottom tier (15) on the iron bracket (13)、(14) pressing holes with M3*8 screws.
7. Screw iron bracket 6.3" (16), 8.6" (17) on the lamp body (12) dressing holes with M3*8 screws.
8. Screw the bottom tier (18) on the iron bracket (16)、(17) pressing holes with M3*8 screws.
9. Screw the threaded pipe (19) on the joint (20), install the cover pipe into the tier pipe (22) both sides, cover the tier pipe (22) and bottom tier (18) on the threaded pipe (21), screw them well with tower shaped (19).
10. Pass the main wire through the (05) (04) (03) (02), screw it with (01), then hang it on the ceiling.
11. Pull up the steel wire through the lamp body arrive the Mounting bracket the fix it.
12. Make sure the main wire is enough long and keep the rest wire in the J-box.
13. As the crystal pressing instruction, hang the crystal parts.

NOTE: The fixture has the steel wire, you can't cut it, please use the steel wire and pull up it to the canopy to fix the fixture.

The end!

12

Step 4 Crystal Dressing Instructions

1. Hang crystal "A" "B" "C" "D" "E".

Crystal Dressing Diagram



When dressing the chandelier with the crystals please remember to wear either rubber or cotton gloves. So as to prevent any damage or smudging on the crystals.

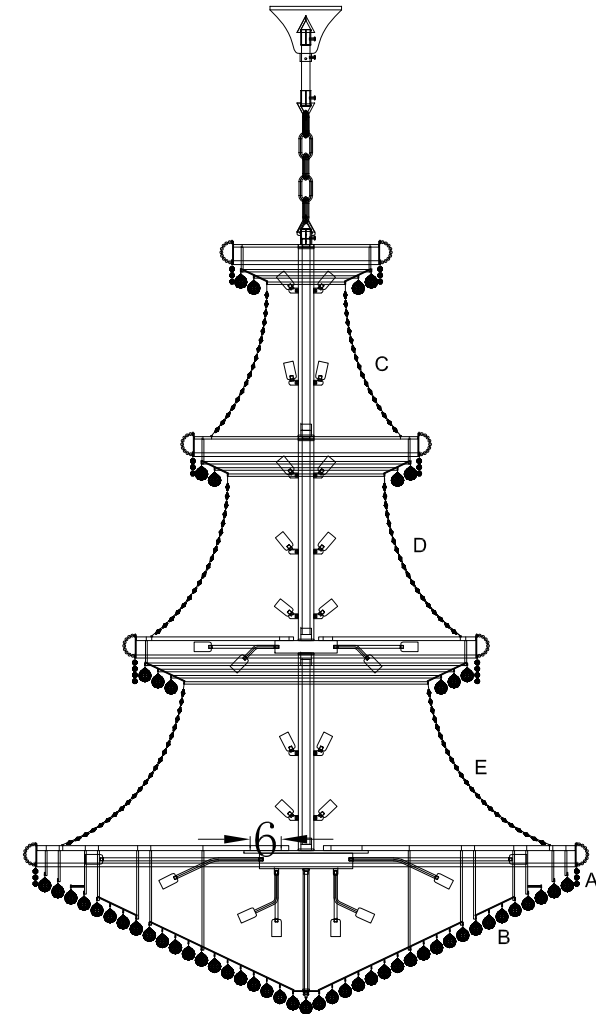

Elegant Lighting Warranty

The finish and frame of your new chandelier or fixture are warranted for a period of one (1) year from the date of purchase. Our company will, at its option, repair or replace any frame that has a defect in the materials or workmanship during the warranty period. All crystals are guaranteed for their original quality during the life of the chandelier. Breakage is not covered by this warranty.

To make a claim under this warranty, contact our customer service department.

A written return authorization form will be sent to you with specific instructions.

Returns and Conditions of Warranty

Returns must be pre-authorized by contacting the retailer where you made your purchase..Returns will only be accepted with a written return merchandise authorization and return shipping charges pre-paid. We reserve the right to inspect all returned merchandise to fully determine the nature of any defect. This guarantee shall not apply to any product that has been changed, altered or otherwise modified, nor shall it apply to any product that has been repaired or altered by anyone other than a pre-authorized facility. We will not be responsible for any breakage or damages incurred during transit, nor for crystal parts or metal frame part that have been subject to misuse, negligence, accident or inappropriate handling. Also, we will not be held responsible for damage incurred during improper installation or wiring by others, nor for damages resulting from a failure to follow the recommended maintenance or installation procedures. This guarantee is issued in lieu of any and all other guaranteed or warranty, whether written or implied and any and all other obligations or liabilities. Further, we neither authorize nor permit any other person or firm to assume for us, any liability in connection with the sale of our products.

Elegant Lighting Warranty

The finish and frame of your new chandelier or fixture are warranted for a period of one (1) year from the date of purchase. Our company will, at its option, repair or replace any frame that has a defect in the materials or workmanship during the warranty period. All crystals are guaranteed for their original quality during the life of the chandelier. Breakage is not covered by this

To make a claim under this warranty, please contact the retailer where you made your purchase. A written return authorization form will be sent to you with specific instructions.

Returns and Conditions of Warranty

Returns must be pre-authorized by contacting the retailer where you made your purchase..Returns will only be accepted with a written return merchandise authorization and return shipping charges pre-paid. We reserve the right to inspect all returned merchandise to fully determine the nature of any defect. This guarantee shall not apply to any product that has been changed, altered or otherwise modified, nor shall it apply to any product that has been repaired or altered by anyone other than a pre-authorized facility. We will not be responsible for any breakage or damages incurred during transit, nor for crystal parts or metal frame part that have been subject to misuse, negligence, accident or inappropriate handling. Also, we will not be held responsible for damage incurred during improper installation or wiring by others, nor for damages resulting from a failure to follow the recommended maintenance or installation procedures. This guarantee is issued in lieu of any and all other guaranteed or warranty, whether written or implied and any and all other obligations or liabilities. Further, we neither authorize nor permit any other person or firm to assume for us, any liability in connection with the sale of our products.