



ELEGANT

FURNITURE & LIGHTING™

Installation manual for:

V1800G36S

Dimensions:D36" H43" L28

Collection:Primo

Bulb Type:E12 bulb not included

Lamp Frame Weight(lbs):36

Total Weight(lbs):171



Thank you for choosing our product(s).

Our Company is actively involved in every step of the production.

Our product(s) are designed to be utilized for every application that graces your home or business.

We pride ourselves in providing the most prompt and courtesy service to all of the valued customers.

Please find the enclosed detailed instruction and read carefully for proper installation.

If you have any questions, please contact the retailer where the purchased was made.

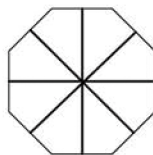

SAFETY

Warning: MAKE SURE THE ELECTRICITY TO THE WIRES YOU ARE WORKING ON IS SHUT OFF. BY EITHER REMOVING THE FUSE OR TURNING OFF THE CIRCUIT BREAKER.

CAUTION

- Before assembling the lighting fixture, please read all instructions carefully.
- All frame & crystal components are fragile, please handle with care.
- Required supply circuit : 110 - 130V/60Hz
- Labeled wires are "L" for live wire, "N" for neutral wire, "E" for ground wire.
- Never install fixture on damp ceiling, the room should be dry and well ventilated
- All electrical components must be installed by a licensed electrician and in accordance with the National Electrical Code and the appropriate local electrical codes.

Unpack the Package

Please open the box carefully and check all the items are inside the box. If you have any installation, assembling and missing parts questions, where you purchase from and any other relevant information ready, our customer service team will provide comprehensive and worry free service to our valued customers.

Frame Parts List

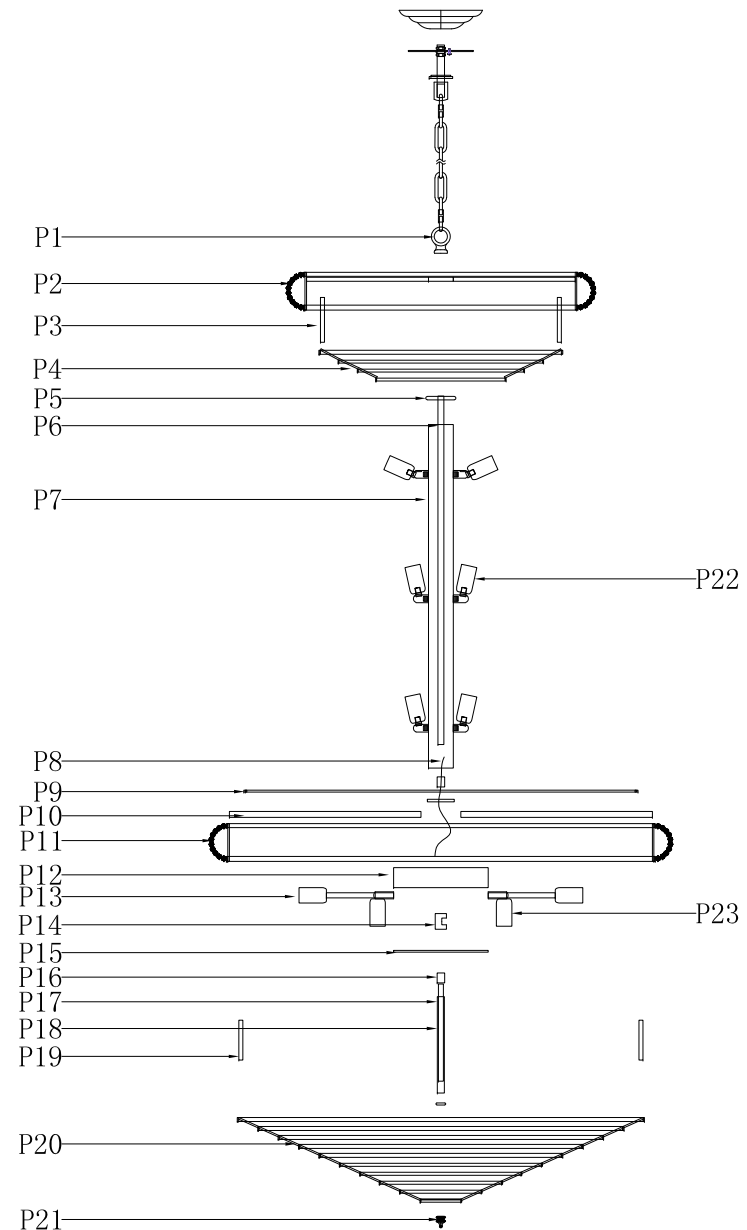









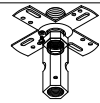

V1800G36S D36" H43" L28

Step 1

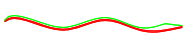
Please use the parts list to ensure you are not missing any parts











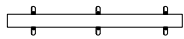

V1800G36S

PARTS LIST

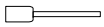
part	picture	Description	Parts Number	Qty	Check list
ZA		4"Crossbar	CP10R60L3	1	
ZB		6"Canopy cover		1	
ZC		Canopy ring		1	
ZD		L59"CHAIN06T Twist Design	CHAIN06T	1	
ZE		Power Cord 12' SPT-2-16# Clear/Gold		1	
P1		Loop		1	
P2		Lamp body (1)		1	
P3		3.5"Iron bracket		4	
P4		19"Frame		1	
P5		Cover		4	
P6		26.4"Threaded pipe		1	







03

V1800G36S D36" H43" L28

part	picture	Description	Parts Number	Qty	Check list
P7		26.6"Metal tube		1	
P8		Steel wire		1	
P9		31.3"Metal ring		1	
P10		15.2"Iron bracket		1	
P11		Lamp body (2)		1	
P12		7"Metal wire box		1	
P13		Socket		10	
P14		Hickey		1	
P15		Metal cover		1	
P16		Coupling Attach to the frame		2	
P17		7.7"Threaded pipe		1	
P18		7"Metal tube		1	
P19		4"Iron bracket		8	

04

V1800G36S D36" H43" L28

part	picture	Description	Parts Number	Qty	Check list
P20		32"Bottom		1	
P21		Finial		1	
P22		Socket		13	
P23		Socket		5	
B		1050-14#*3pcs		260	
C		1050-14#*35pcs		68	
D		701-40#		421	

V1800G36S D36" H43" L28

part	picture	Description	Parts Number	Qty	Check list

Step 2 Canopy Installation Instruction

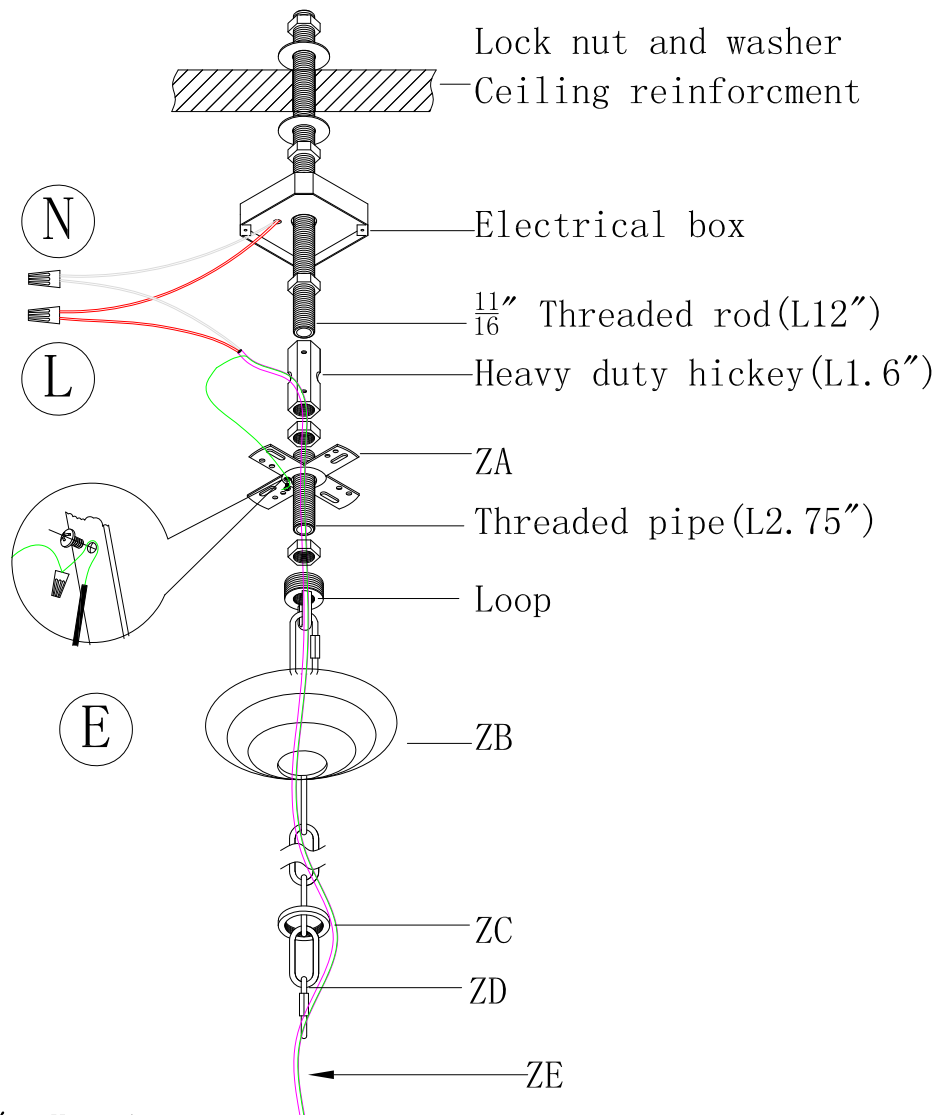

"L" = Hot wire
"N" = Neutral wire
"E" = Ground wire

IMPORTANT: Test sockets with bulb before dressing the fixture.

- 1 .Drill a $\phi 0.7$ " hole in the ceiling reinforcement to allow a $\frac{11}{16}$ " threaded rod to pass through.
- 2 .Attach the electrical box to the ceiling reinforcement and pass the $\frac{11}{16}$ " threaded rod through the box and secure it to the heavy duty hickey.
- 3 .Pass the fixture wires and ground wire through the loop, canopy ring, center hole of canopy and the heavy duty hickey.
- 4 .Pull ceiling wires down through the fixture box and make connection.
- 5 .Screw loop only onto threaded pipe.
- 6 .Hang the fixture on chain.
- 7 .Secure the canopy with canopy ring.

Frame Assembly Diagram

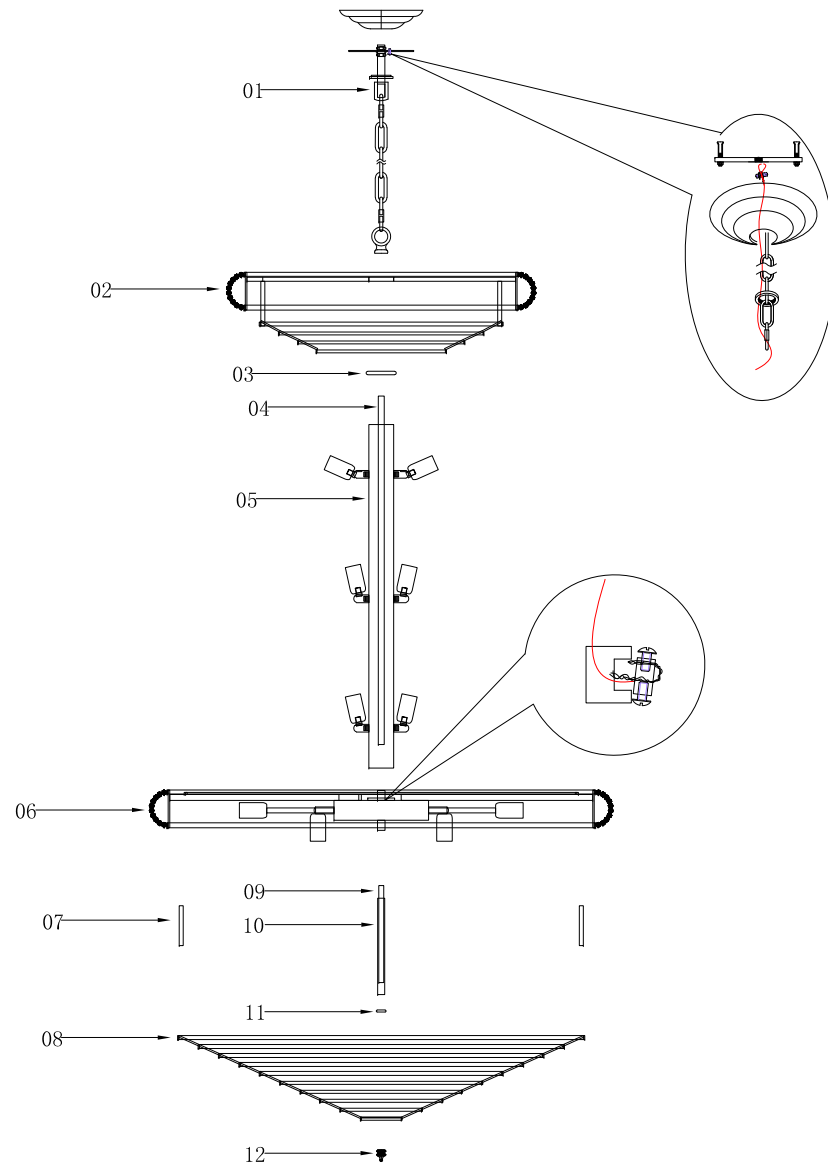

09

Step 3

Frame Assembly Instructions

Installation:

Please read all instructions carefully.
 Before you proceed to install, make sure
 that the power supply is turned off and
 remains off until installation is complete.
 Please note that each part has been assigned a number.
 Please proceed in a numerical order.

1. Hang the chain (01) on the ceiling.
 2. Screw the iron bracket (07) on the lamp body (06) pressing holes with M3*16 screws.
 3. Screw the threaded pipe (09) on the lamp body (06).
 4. Cover the tier pipe (10) and small pipe cover (11) on the threaded pipe (09), screw bottom tier (08) on the iron bracket (07) pressing holes with M3*8 screws, screw them with tower-shaped (12).
 5. Connect the lamp body (06) main wire, tier pipe (05) main wire and the longer main wire.
 6. Screw threaded pipe (04) on the lamp body (06).
 7. Install the big pipe cover (03) into the tier pipe (05) both sides, cover the tier pipe (05) on the threaded pipe (04), then pass the top tier (02), screw them with chain (01) bottom ring.
 8. Pull up the steel wire through the lamp body arrive the Mounting bracket the fix it.
 9. Hang the all lamp on the chain (01) bottom.
 10. As the crystal dressing instruction, hang the crystal parts.
- NOTE: The fixture have the steel wire, you can't cut it, please use the steel wire and pull up it to the canopy to fix the fixture.

The end!

10

Step 4 Crystal Dressing Instructions

1. Hang crystal "B" "C" "D".

Crystal Dressing Diagram



When dressing the chandelier with the crystals please remember to wear either rubber or cotton gloves. So as to prevent any damage or smudging on the crystals.

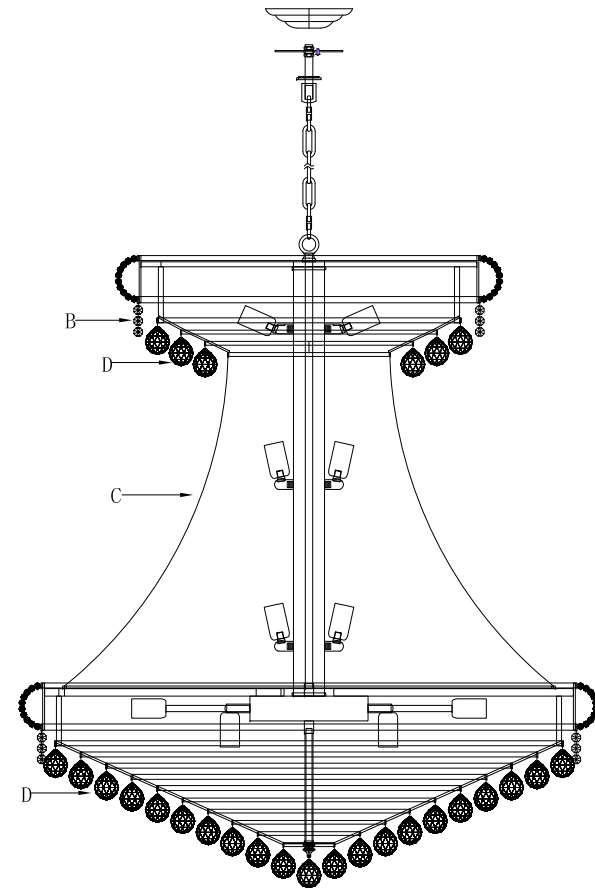

Congratulations !

You are now done installing your Elegant Lighting fixture. Sit back and admire each crystal as it will become the statement piece for your room/house.

Thank you.

Cleaning and Maintenance of Chandelier Frame

The finish on our chandelier frames and fixture frames is protected by a durable coating of lacquer. To clean, use a clean soft, dry cloth. Do not use any metal polishes, cleaners, abrasives or any substance which could remove the protective finish. Failure to follow these instructions automatically voids the guarantee.

Cleaning and Maintenance of Crystals

Wet a soft cotton fabric in clean warm water and wipe gently, then polish with a dry soft cotton fabric.

To Order Crystal Replacement Parts

Should you require replacement crystals or pins (the metal connectors attaching the crystals), contact the store where the product was purchased. For ease of ordering, you may use the original crystal trimming instructions provided with this product and circle the items you wish to order, indicating the quantity by writing the number needed adjacent to the circle. You will be contacted with prices prior to shipment. All orders must be pre-paid.

Elegant Lighting Warranty

The finish and frame of your new chandelier or fixture are warranted for a period of one (1) year from the date of purchase. Our company will, at its option, repair or replace any frame that has a defect in the materials or workmanship during the warranty period. All crystals are guaranteed for their original quality during the life of the chandelier. Breakage is not covered by this warranty.

To make a claim under this warranty, contact our customer service department.

A written return authorization form will be sent to you with specific instructions.

Returns and Conditions of Warranty

Returns must be pre-authorized by contacting the retailer where you made your purchase..Returns will only be accepted with a written return merchandise authorization and return shipping charges pre-paid. We reserve the right to inspect all returned merchandise to fully determine the nature of any defect. This guarantee shall not apply to any product that has been changed, altered or otherwise modified, nor shall it apply to any product that has been repaired or altered by anyone other than a pre-authorized facility. We will not be responsible for any breakage or damages incurred during transit, nor for crystal parts or metal frame part that have been subject to misuse, negligence, accident or inappropriate handling. Also, we will not be held responsible for damage incurred during improper installation or wiring by others, nor for damages resulting from a failure to follow the recommended maintenance or installation procedures. This guarantee is issued in lieu of any and all other guaranteed or warranty, whether written or implied and any and all other obligations or liabilities. Further, we neither authorize nor permit any other person or firm to assume for us, any liability in connection with the sale of our products.