

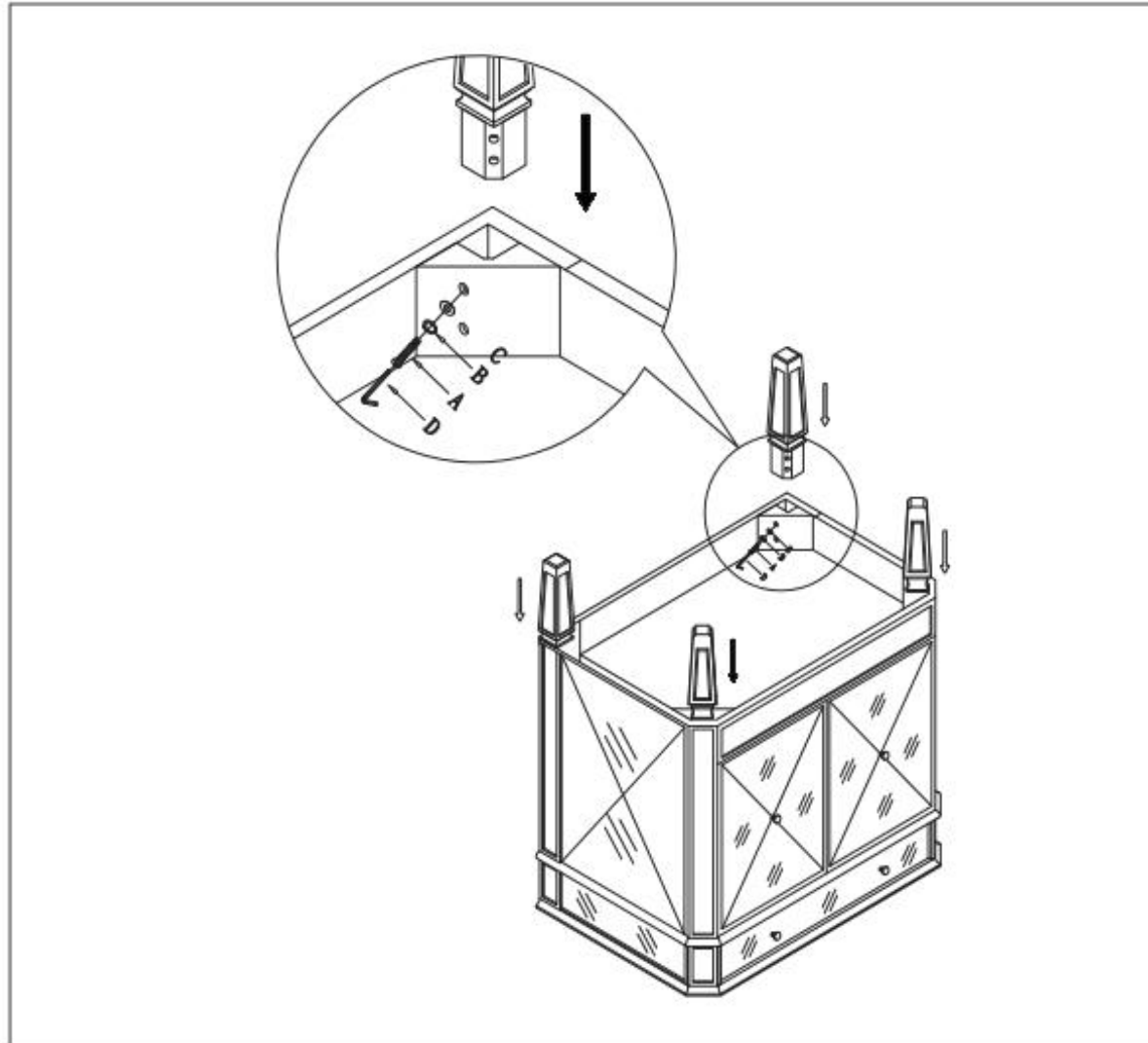





ELEGANT
FURNITURE & LIGHTING™

ITEM#: MF6-1102GC

ASSEMBLY INSTRUCTION

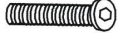

HARDWARE LIST

No	FIGURE	DESCRIPTION	Q'TY
A		BIGGER HEX BOLT	8
B		SPRING WASHER	8
C		FLAT WASHER	8
D		ALLEN KEY	1

